

**2021**

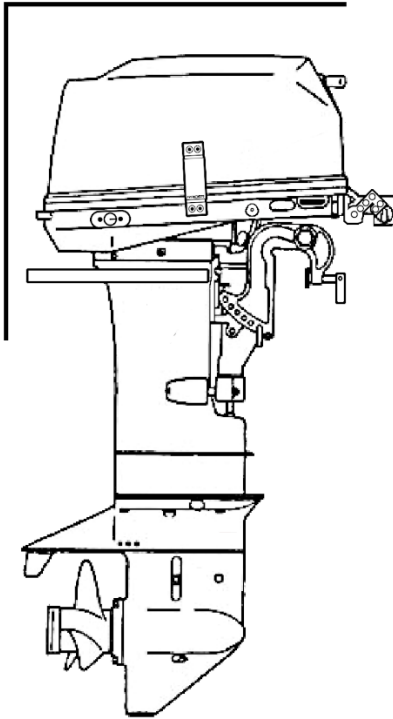

# **OWNER'S MANUAL**

**RAIDER 40 HORSEPOWER  
SUBMERSIBLE /  
MULTI-FUEL  
OUTBOARD MOTOR  
NSN 3H 2805-01-652-3067  
PART NO. R40ES-002**

**RAIDER OUTBOARDS  
1855 SHEPARD DRIVE  
TITUSVILLE, FL 32780  
321-383-9585**

**FOR MILITARY USE ONLY**

**RAIDER OWNER'S MANUAL NO. R40-ES-002-01  
INSTRUCTIONS FOR OPERATIONS WITH THE 40HP OUTBOARD ENGINE  
'OWNER'S MANUAL'**

**RAIDER 40**

**This page intentionally left blank**

# RAIDER *Outboards*

## **MULTI-FUEL SUBMERSIBLE ELECTRIC START OUTBOARD ENGINES**

The Raider series of outboard motors are dedicated to the Marine Raiders established by the United States Marine Corps during WWII and are said by many to be the first United States special operations force. Handpicked from the elite, these men were given specialized training and the best equipment. They distinguished themselves during the conduct of clandestine amphibious landings, utilizing small inflatable boats, operating behind enemy lines in direct support of combat operations in the Central Pacific and Solomon Islands. Even though the Raiders were disbanded at the close of WWII the need for specially trained warfighters and the requirements for specialized equipment did not. Today's Special Operations Forces (SOF) under the United States Special Operation Command (USSOCOM) are expected to conduct similar and far more demanding missions, to that end and with those warfighters in mind the Raider (OBM) is specifically developed for SOF that routinely operate within the often unforgiving, highly demanding, dynamic maritime environment.

### **WHO WE ARE**

- Raider Outboards, Inc. is a-US owned and operated company based in Central Florida near Kennedy Space Center, located in the Space Port Commerce Park. We design and produce multi-fuel, submersible, lightweight outboard motors and associated parts that include a Safety Jet; transom plates; carts and transportation cages. Our markets include Department of Defense (DOD), Other Government Agencies (OGA), National and Local Law Enforcements and First Responder Services, Search & Rescue and commercial/retail.
- The Raider patented Safety Jet can be purchased in a kit which retrofits a propeller drive to a jet pump system. The Safety Jet was designed to improve safety for swimmers and divers in both real-world and training situations. The Safety Jet is excellent for "brown water" operations where search and rescue operations routinely happen in which higher probabilities of striking submerged objects exist. For coastal or beaching operations in unfamiliar waters it provides additional protection from rocks or coral easily absorbing hits that could ruin propellers when moving to and from a beach landing site.
- Raider also provides a series of transom plates that are attached to the transom of the Combat Rubber Raiding Craft (CRRC). The transom plates have single and dual motor configurations. The transom plates provide centerline alignment and safety if the motor clamps loosen under vibration. Specialty items like extended handles, extended fuel hose connections, outboard motor carts and transportation cages are also available.

## WHAT WE ARE ABOUT

Raider Outboards develops, manufactures, and provides technical support services for highly reliable outboard motors for today's warfighter. Our designs are field proven, and add capacity and capability to perform the most difficult and demanding maritime missions. Features include;

- Simple and Robust.
- System Redundancy.
- Minimized Electronics.
- Air droppable.
- Bagless submersion.
- Superior dewatering.
- Leader in horsepower to weight ratio.
- 25% better fuel efficiency than any other motor in its class.
- Easy to maintain and troubleshoot.

## OUR MISSION

Raider Outboards will provide and deliver the most reliable premium products, hands on training, and highest quality to the customer and serve as the premier outboard motor company to the U.S. Military; while honoring those who protect, defend, and support our communities and our country.



Chris Woodruff  
Director of Engineering  
Raider Outboards Inc.  
Chris@raideroutboards.com  
321-567-2309

*Chris Woodruff*

## YOUR RAIDER OUTBOARD MOTOR

- a. The Raider R40ES-002 NSN 3H 2805-01-652-3067 outboard motor is designed specifically for and specially manufactured for the Department of Defense for use as the main propulsion system on Combat Rubber Raiding Craft (CRRC). The Raider brings additional capability far superior to any other motor in its class. This motor can be submerged, without bagging, for extended periods and quickly restarted; operates on multiple fuels; equipped with an electric start feature utilizing an engine start battery located under the cowling.
- b. We would like to emphasize that optimum motor operational performance can only be assured on the condition that this manual is read through in its entirety and the maintenance routines described later are followed carefully. Should difficulty arise with the motor, please follow the troubleshooting procedures listed throughout the specified sections within this manual. For any other issues, questions, or concerns please call 321-567-2306 or contact [TechSupport@raideroutboards.com](mailto:TechSupport@raideroutboards.com) where our trained staff of subject matter experts will provide you with any assistance required.

## OWNER REGISTRATION AND IDENTIFICATION

- a. This Raider outboard has been purchased by the Department of Defense. Every motor has been delivered under Form DD-240 which contains individual Serial Numbers and Raider Outboards has a record of every motor delivered.
- b. Serial Number: In the space provided below, please record the outboard motor's serial number which is indicated on the starboard side of the cylinder block. The serial number will be needed in ordering spare parts.
- c. Serial Number: \_\_\_\_\_

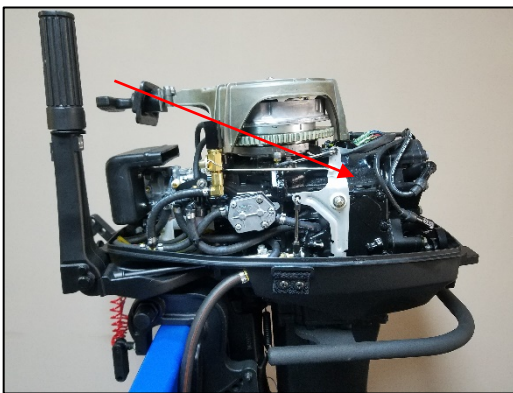

## LIMITED WARRANTY

- a. Raider Outboards Motors are fully guaranteed against defective materials and workmanship for the period from the date of the Form DD-240 for one year. The limited warranty will not apply to the normal wear and tear of parts, adjustments, tune-ups, or to any damage caused by:
  1. Use or operation **NOT** conforming to the instructions described in this owner's manual.
  2. Damaged caused as a result of parachute failure or improper parachute rigging.
  3. Damage, Deterioration, or Corrosion resulting in motor failure due to improper conduct of Pre and Post Operations Checks. The Raider 40 HP Outboard must be flushed with fresh water and washed down after use.
  4. Improper dewatering. Damage caused by failure to adhere to the dewatering procedures.
  5. Damage from accidents, collisions, contact with foreign materials, or submersion without cleaning.
  6. Growth of marine organisms on motor surfaces that exceeds recommended submergibility times or left in the water between operational periods.
  7. Any other careless use or operation issues. (Battery unplugged when not in use)
  8. Normal deterioration.
- b. The limited warranty does not cover maintenance items. The following items are some examples not covered by the limited warranty.
- c. Spark plugs, anodes, trim-tab, propeller, fuel filter, Starter rope, split-pin, bolt/nut washer, wire cable. Rubber goods: pump impeller. Oil seal, "O"-ring, fuel line, primer bulb, etc., vinyl tube.
- d. The limited warranty will cover only your Raider Outboards 40HP and will not cover the craft the motor is mounted on, the trailer, equipment, or accessories associated with the product.

## THIS MANUAL

- a. This owner's manual provides information that is needed for inspection, procedures to prepare the motor for an operational cycle, preventative maintenance and troubleshooting of the Raider Outboards 40HP. Additional information about specific systems and parts are described within the service and parts manuals. These manuals including this one may be found on the Raider Outboards web site [raideroutboards.com](http://raideroutboards.com) and may be downloaded for convenience. Should additional information be required please call or email customer service department at 321-567-2306 or [TechSupport@raideroutboards.com](mailto:TechSupport@raideroutboards.com).
- b. For our users we have built the best outboard motor for long term, it is essential for the maintainer to prepare the outboard prior to the operational period. To ensure this, the maintenance and service have to be done properly by a service technician with fundamental knowledge and skills. This manual is utilized so that our operators can always use their outboard motor with full satisfaction.

# CONTENTS

|  |    |
|--|----|
| <b>GENERAL INFORMATION</b> .....           | 1  |
| Safety Information.....                    | 1  |
| Notice: Danger/Warning/Caution/Note.....   | 1  |
| Emergency Stop Switch .....                | 2  |
| Raider Maintenance Tool Kit.....           | 2  |
| Raider Emergency Tool Kit .....            | 3  |
| Capabilities/Features.....                 | 4  |
| Specifications.....                        | 6  |
| Components and Controls.....               | 8  |
| Fuel Requirements .....                    | 18 |
| Hazardous Material Requirements.....       | 20 |
| Break-In .....                             | 21 |
| <b>STANDARD OPERATING PROCEDURES</b> ..... | 22 |
| Pre and Post Operations Checks .....       | 22 |
| Pre-Operations Checks.....                 | 23 |
| Operational Checks.....                    | 26 |
| Post Operations Checks.....                | 28 |
| Motor Mounting.....                        | 29 |
| Propeller Selection .....                  | 30 |
| Starting the Raider 40 HP .....            | 31 |
| Maneuvering .....                          | 34 |
| Trim Adjustments .....                     | 35 |
| Shallow Water Running/Beaching.....        | 37 |
| Dewatering .....                           | 38 |
| Emergency (Tertiary) Starting .....        | 41 |
| <b>MAINTENANCE REQUIREMENTS</b> .....      | 42 |
| Tach/Hour Meter.....                       | 43 |
| Spark Plugs.....                           | 44 |
| Carburetor Tuning .....                    | 46 |
| Timing.....                                | 48 |
| Cylinder Compression Test.....             | 49 |



|   |    |
|---|----|
| Gear Oil Change.....                    | 51 |
| Gearcase Pressure and Vacuum Tests..... | 53 |
| <b>TROUBLESHOOTING</b> .....            | 54 |
| <b>APPENDICES</b> .....                 | 56 |
| Pre Operations Checklist .....          | 57 |
| Post Operations Checklist.....          | 61 |

**GENERAL INFORMATION**

**SAFETY INFORMATION**

As the operator or coxswain of your craft, first and foremost, you are personally responsible for the safety of the crew, embarked personnel, and any person in the water or in the vicinity of the craft. Safety is paramount in all operations. Therefore, you should possess thorough knowledge of correct operation of your craft, its accessories, and the Raider Outboard Motor. This manual details the proper procedures, correct operation and maintenance of the motor. Additional hands on training courses for both the operators and technicians are available through Raider.

**NOTICE: DANGER/WARNING/CAUTION/NOTE**

Before installing, operating or otherwise handling your Raider Outboard Motor, be sure to thoroughly read and understand this operations section of this manual and carefully follow all of the instructions. Of particular importance is information preceded by the words "DANGER," "WARNING," "CAUTION," and "Note." Always pay special attention to such information to ensure safe operation of the outboard motor at all times.

The following safety statements are found throughout this manual and indicate information which, if ignored, could result in fatal safety hazards or property damage.



**Failure to observe will result in severe personal injury or death, and possibly property damage.**



**Failure to observe could result in severe personal injury or death, or property damage.**



**Failure observe could result in personal injury or property damage**



**This instruction provides special information to facilitate the use or maintenance of the outboard motor or to clarify important points.**

**EMERGENCY STOP SWITCH**

The Emergency Stop Switch will stall the outboard motor when the stop switch tether is pulled off. This stop switch tether can be attached to the operator of the outboard motor to minimize or prevent injuries from the propeller in case the operator falls overboard. We highly recommend use of the Emergency Stop Switch tether.



**Accidental activation of the Emergency Stop Switch (such as the tether being pulled out in heavy seas) could cause passengers to lose their balance and even fall overboard, or it could result in loss of power in heavy seas, strong currents, or high winds. Loss of control while mooring is another potential hazard.**

**RAIDER MAINTENANCE TOOL KIT**

The Raider Maintenance Kit (RMK) is a complete tool set that is specifically designed and provides Operators and Field Service Technicians with the necessary tools to perform routine maintenance actions or intermediate level motor troubleshooting and repair to the component level. The tools are stowed and secured in a waterproof case for ease of transport and protection from harsh environmental conditions. For inquiries into purchase of the RMK please contact Raider at [sales@raideroutboards.com](mailto:sales@raideroutboards.com) or 321-567-2307 by phone for information.



**RAIDER EMERGENCY TOOL KIT**

Included with each Raider Outboard Motor is a Raider Emergency Field Kit (EFK). This includes tools for underway troubleshooting and emergency repairs and spare parts. The tools and parts provided are contained inside a small waterproof case designed for easy stowage and is intended to be carried onboard the craft as part of the operational load out. This kit is not inclusive and additional items may be required based on organizational Standard Operating Procedures (SOP). The EFK includes the following items:



| Part Number    | Qty  | Description                       |
|----------------|------|-----------------------------------|
| <b>SBE110</b>  | 2    | Spark Plug                        |
| <b>841140</b>  | 1    | M10 Deep Socket 3/8 Dr            |
| <b>841156</b>  | 1    | M16 Deep Socket 3/8 Dr            |
| <b>841153</b>  | 1    | M13 Deep Socket 3/8 Dr            |
| <b>2292340</b> | 1    | Stanley 6 way screwdriver         |
| <b>67149</b>   | 1    | Crescent Wrench                   |
| <b>375532</b>  | 1    | Pliers                            |
| <b>68513</b>   | 1    | 3/8 Hex drill socket              |
| <b>63518</b>   | 1    | 1800 Weatherproof Pelican Case    |
| <b>400B</b>    | 7 FT | #5.5 Starter Cord                 |
| <b>24002</b>   | 1    | 2 oz. tube Corrosion Block Grease |

**CAPABILITIES/FEATURES****Multi-fuel**

Dependent upon fuel available. The Raider 40 HP is capable of using multiple fuel sources for operation. Gasoline, is the recommended fuel but should the mission or situation dictate various types of Heavy Fuel combined with the Raider Additive may be used. Regardless of fuel type utilized for operations there still exists the requirement for mixing with 2 cycle oil at the ratio of 50:1.

**Submersible**

Allows for full submersion, in salt water, without bagging to a depth greater than 65ft for periods exceeding 24 hours.

**Dewatering**

Upon recovery to the surface fully operational within 10 minutes. Easy instructions for dewatering are provided affixed to each engine cowling of every outboard motor. Most operators, with practice and adherence to the provided instructions, restore the motor to operations within two minutes of surfacing. Skilled operators are able to achieve lite off in as few as 30 seconds.

**Air Deployable**

When required is capable of being dropped from both fixed wing and rotary aircraft. Battery cutoffs are available to preserve start battery life in drop packages for over 180 days. Prior to drop, the operator enables the start battery should expeditious start be required on the drop zone.

**Lightweight**

Maneuverable through the hatch of a Submarine or mounting when underway. The motor is easily maneuvered by two personnel through the hatches of ships or submarines by using the installed reinforced no slip grab handles and rails. The special rail design allows the motor to be stowed in an upright position of the deck or pallet instead of laying on its side.

**Electric Start**

Provides fast starting in duress situations and aids in dewatering. The installed Acid Glass Matt Battery adds the ability to start the motor without the use of the recoil starter. This capability may prove to be invaluable where starting the motor is not practical via the primary method due to motor damage, operator injury, or prevailing environmental conditions will not afford such. When used with dewatering it rapidly expels any water through the decompression valves.

**Tactical Communications Power Interface**

Power and charge tactical communications systems. Various types of connectors may be installed per the requirement of the operator. Power tactical radio systems through battery eliminators, charge cell phones or even power a spot light.

**Bolt on Safety Jet**

Prevents injury to personnel from inadvertent contact with the propeller. Moreover, provides increased reliability during beaching or Search and Rescue applications supporting hurricane relief and emergency response. Protects crafts propulsion systems when transiting through shallow and flooded areas from unseen obstructions that when struck would normally render a craft dead in the water.

**Transportation Cage and Cart.**

Allows for safe secure storage of motor when not in use or being transported over the road or by air. Raider provides two-part system, consisting of a cart and cage. The cart provides a mobile mount for the performance of maintenance actions and repairs. For safe secure storage the cart maybe locked into place inside the Transportation Cage. This provides extra protection when conducting movement via land or by Military Air ensuring your motor arrives in theater ready for immediate operations.

**Engine Cover**

Protects motor from prevailing environmental conditions should the need require stowage in less than ideal conditions or outside. A specially designed breathable material allows moisture to evaporate.

**Transom Plates**

Provides a means for repetitive, expeditious, safe, and secure mounting of the motor on any marine craft transom. These plates provide a guide for the stern bracket of the motor that will automatically center the Raider 40 to the keel (center line) of the craft. Then simply tighten the stern bracket screws.

**Twin Motor Mount System**

A dual control mounting system that supports two Raider Outboards on the same transom. In conjunction with the Raider Transom Plate the dual control system can be attached quickly allowing operation of both steering and throttle control using a single tiller arm. The tiller arm may be extended for easier movement by adding the tiller extension.

## SPECIFICATIONS

| ITEM                      | RAIDER 40 HP<br>NSN 3H 2805-01-652-3067                 |
|---------------------------|---|
| Overall length            | 38.18 inches (919 mm)                                   |
| Overall width             | 13 inches (330.2 mm)                                    |
| Overall height            | 49 inches (1245 mm) (Long Shaft)                        |
| Weight                    | 148 lbs. (67kg)   |
| Transom length            | 20.9 in. (530 mm) (Long Shaft)                          |
| Engine type               | 2-Stroke Throttle Body                                  |
| Piston Displacement       | 493 cc  |
| Bore and Stroke           | 2.76 x 2.52 (70 mm x 64 mm)                             |
| Number of cylinders       | 2   |
| W.O.T.                    | 5200 – 5800 rpm   |
| Exhaust System            | Through Hub   |
| Cooling System            | Water cooling (Rotary rubber impeller)                  |
| Ignition System           | C.D. ignition   |
| Starting System           | Pull Start; Battery; emergency rope start               |
| Intake System             | Reed Valve  |
| Lubrication system        | Fuels pre-mixed with additives                          |
| Cooling system            | Forced Water-cooling                                    |
| Water temperature control | Thermostat (with pressure relief valve)                 |
| Ignition System           | Flywheel Magneto C.D. Ignition                          |
| Gear Reduction Gear Ratio | 13:25 1.85  |
| Spark Plug                | NBE1H/10 (stainless steel) GAP “.035”                   |
| Alternator                | 12V 280W (Maximum) (13.6 volts regulated)               |
| Battery                   | Acid Glass Mat (AGM), 12VDC @ 10Ah with 175CCA          |
| Trim Angle                | 4-24 degrees  |
| Trim Angle settings       | 6 degrees   |
| Maximum tilt-up angle     | 75 degrees  |
| Transom board thickness   | 31-70 mm (1.22 – 2.76 in.)                              |
| Maximum steering angle    | 80 degrees  |
| Gear shift                | Dog clutch (F-N-R) – front location                     |
| Electric Start            | Push button   |
| Throttle Control          | Tiller Handle   |
| Fuel Bladder/Tank         | Organizational Dependent                                |
| Heavy Fuels               | 50:1 mix, Raider Elixir Additive                        |
| Gasoline                  | 50:1 mix  |
| Engine Oil                | TC-W3 Synthetic Marine Oil                              |
| Gear Oil                  | Synthetic API GL5, SAE#80 to #90 500 ml (16.89 fl. Oz.) |

Owner's Manual

General Information

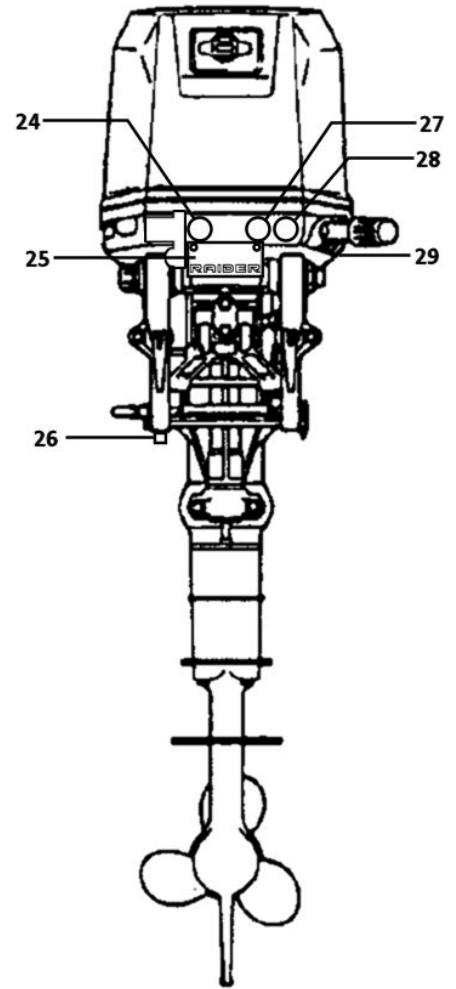
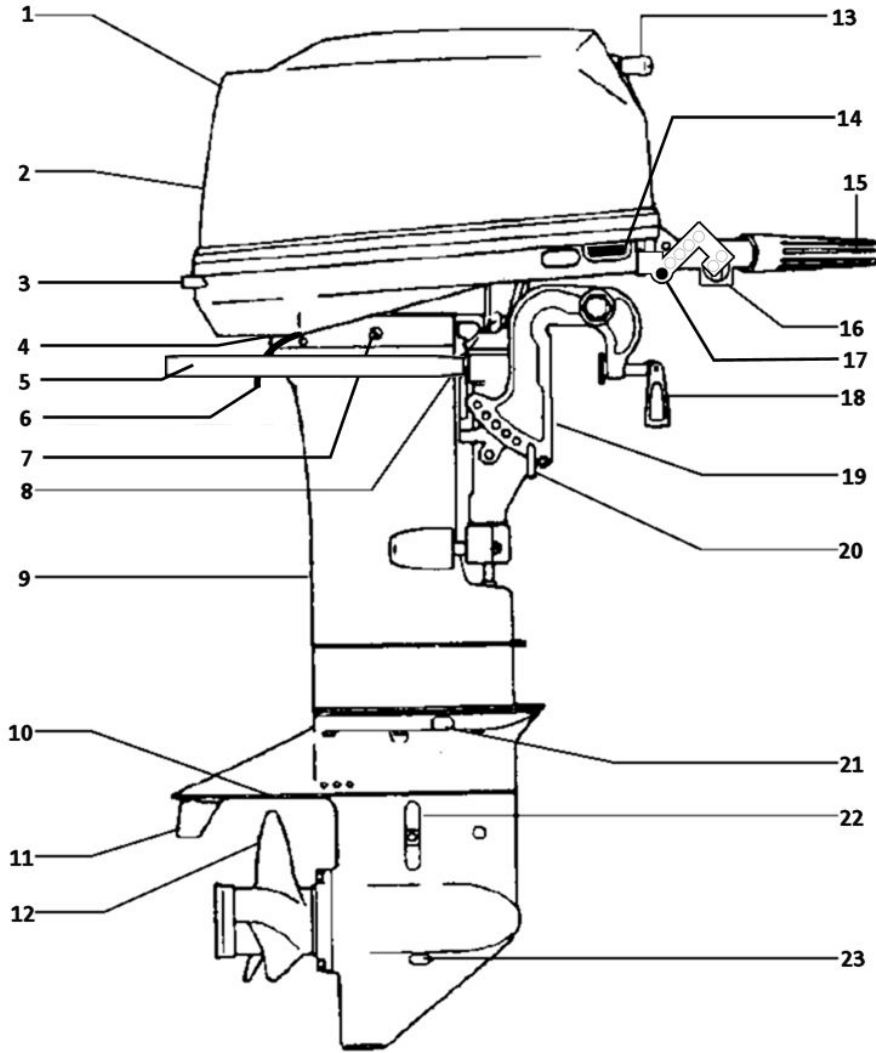

- 1. Tilt Handle
- 2. Top Cowl
- 3. Hook Lever
- 4. Water Check Port
- 5. Rear Carry Grab Rail
- 6. Fuel Overboard Tube
- 7. Water Plug
- 8. Reverse Lock Lever
- 9. Drive Shaft Housing
- 10. Anti Ventilation Plate

- 11. Trim Tab/Anode
- 12. Propeller
- 13. Starter Handle
- 14. Dewatering Lever
- 15. Throttle Grip
- 16. Throttle Tension Adjust
- 17. Shift Lever
- 18. Stern Bracket Clamp
- 19. Stern Bracket
- 20. Thrust Rod

- 21. Oil Plug (Upper)
- 22. Water Inlet
- 23. Oil Plug (Lower)
- 24. Emergency Stop Switch
- 25. Front Grab Handle
- 26. Stern Bracket Anode
- 27. Primer
- 28. Electric Start
- 29. Fuel Connect



COMPONENTS AND CONTROLS

Cowling

A removable cover of the outboard motor that provides protection for the powerhead and components during operation and storage.



Cowling Latch

A mechanism located on the rear portion of the lower engine cover that provides a means to secure the cowling in place.



Cowling Retention Strap

Velcro Straps fixed to the cowling and lower engine cover that prevent the cowling from dislodging during air drop, motor submersion, or craft capsize.



### Pull Handle and Cord

T-Handle grip fixed to the leading end of the pull cord of the recoil starter. Routed through the starter cord opening of the cowling for operator access. This is the primary method used to start the motor.



### Tiller Arm

Mechanical lever that attaches to the swivel bracket that allow the operator to steer the craft to port or starboard. Also provided the mounting structure for the Throttle Control and Throttle Tension Adjustment.



### Throttle Control

Affixed to the end of the Till Arm. Allow the operator to control the acceleration and deceleration of the motor. It provides a raised indicator that aligned for ideal throttle position during motor start.



Throttle Tension Adjustment

A control located on the inboard side of the Tiller Arm. Provides adjustable resistance to movement of the throttle grip and can be set to operator preference.



Forward Carry/Grab Handle

Located on the forward part of the motor. Provides the operator with a secure means to lift the motor for movement or mounting.

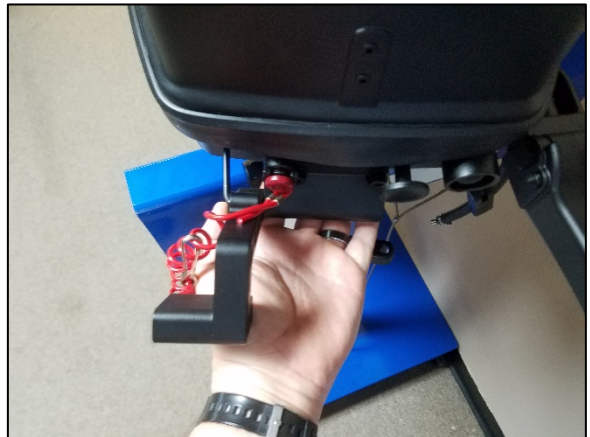

Carry/Grab Rail

Located around the left, right, and rear of the motor. Provides a means for the operator to lift the motor for movement or mounting. Also provides a means for the motor to be laid down in the upright position. Coated with a non-slip surface.



### Dewatering Lever

Mechanical lever located on the right side of the motor. When actuated it opens the Dewatering Valve to expel bad fuel overboard and by means of a rod and fingers it opens Decompression Valves on the cylinder head, so that water may be expelled from the cylinders. Features a detent position, to allow for hands free operation while dewatering.



### Gear Shifter

Located on the forward section of the lower engine cover. Three position lever that allows for selection of forward, neutral, and reverse. Ensure that the throttle is at idle before placing the motor into gear.

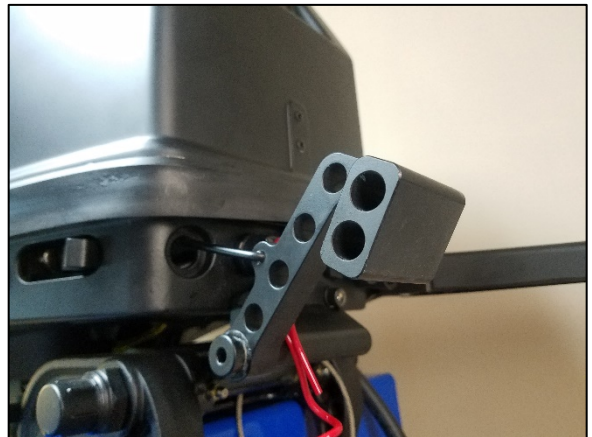

### Tachometer/Hour Meter

Displays the total number hours the Raider Outboard Motor has been operational. A tachometer mode can be selected by the operator for the purpose monitoring motor RPM.

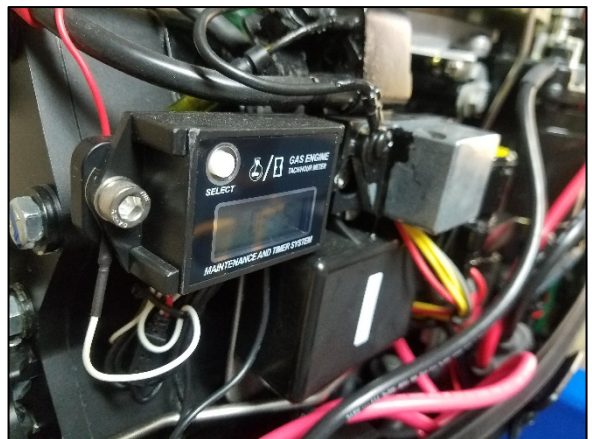

Start Battery

AGM Battery, provides 12vdc @ 10Ah with 175CCA for engine starting. Located in the battery bracket mount on the left side of the powerhead under the cowling.

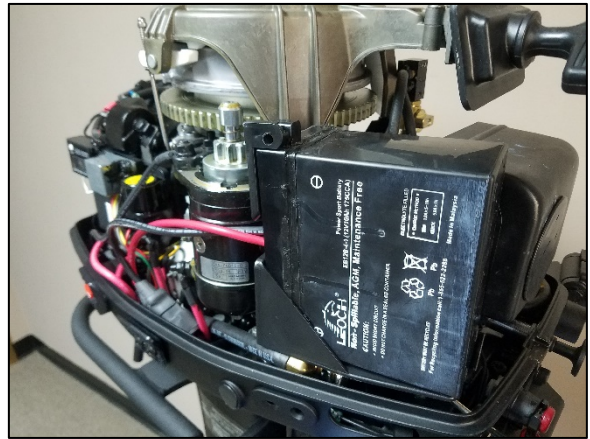

Engine Start Button/Switch

Push button start switch that utilizes battery voltage to activate an electric starter to spin the flywheel. Electric start is protected by an outer ring to prevent inadvertent activation from contact. This is the secondary method to start the motor. Located on the front of the lower engine cover.

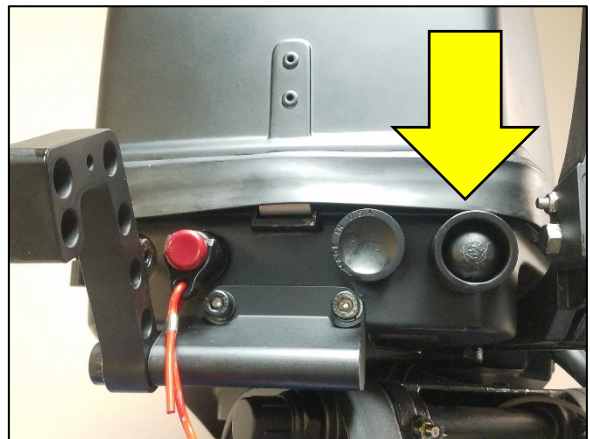

Engine Stop Push Button/Kill Switch

Located on the front of the lower engine cover. Push button switch that when pressed will shut the motor down.

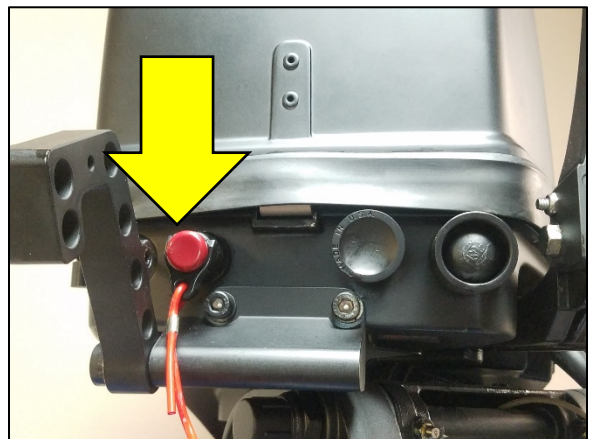

Lock Plate and Lanyard

The lock plate must be attached to the engine stop switch for the engine to start and remain running. The lock plate lanyard should be attached to a secure place on the operators clothing. When the lock plate is removed the motor will stop.



Primer

Located on the front of the lower engine cover. Utilized for cold starts and dewatering. When actuated pumps fuel from the carburetor bowl to the Heavy Fuel Plate to aid in starting.

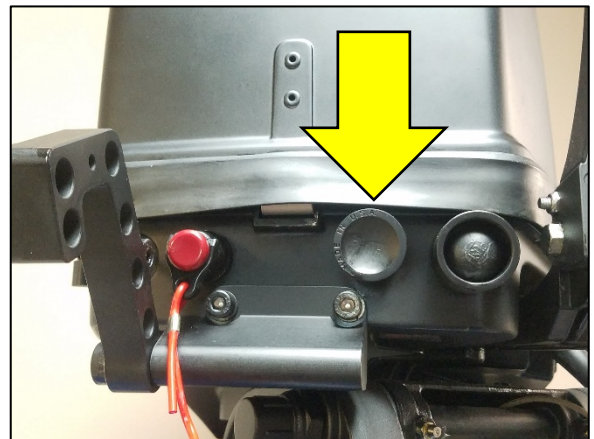

Fuel Overboard Discharge Drain Tube

The through put for the fuel system that provides passage for bad fuel from the fuel system when the Dewatering Valve is opened.



### Stern Brackets

Used to mount the motor to the transom plate. C-shaped clamps that slide over the transom for the purpose of securing the motor for operations.



### Tilt Handle

A two-position lever, when in the fully down position will release the motor to be placed into the Shallow Running Position or full tilt. When in the up position locks the motor in the down position. Located on the right side of the Swivel Bracket.



### Tension Adjustment Bolt

Located Utilized to adjust the tension when moving the motor to the left or right and centering by turning the bolt clock-wise and counter to loosen.



**Thrust Rod (Trim Adjust)**

A removable rod that is inserted through holes in the Stern Brackets that are used to adjust the trim angle of the craft.

**Stern Bracket Anode**

Made of zinc a highly active metal that attracts electrolytes that would normally corrode and weaken the less active metal.

**Oil Level Plug**

Located just Beneath the AV-Plate on the forward portion of the Gearcase. When open it release vacuum in the Gearcase to allow oil to drain freely from the Lower Fill/Drain hole. When filling provided indication that Gearcase is full when oil seeps out the hole.





**Oil Drain Plug**

A magnetic screw, located on the forward bottom of the Gearcase. Removed to drain the oil and provides connecting point for oil fill.

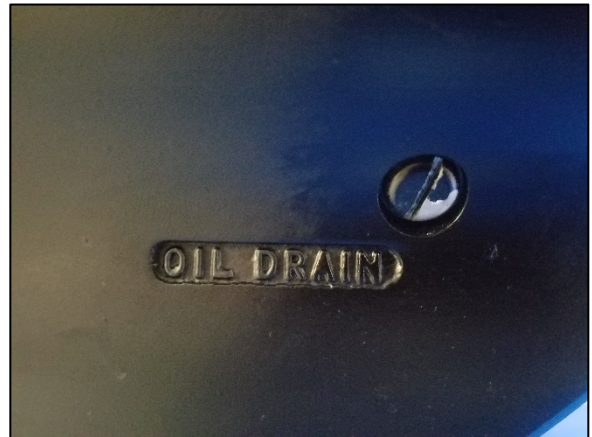
**Exhaust Outlet**

The exhaust relief is located above the AV-plate, allowing the prop to run in clean, exhaust-free water.

**Water Strainer (Set)**

Located on both sides of the Gearcase. A fabricated beveled opening covered by a plastic screen that allows for the intake of water by the impeller for cooling. This is simply a small plastic basket that is tapered and has perforation holes which acts as a filter for larger debris.



Propeller

Three blade aluminum construction, which is able to absorb impact energy to protect drive component.

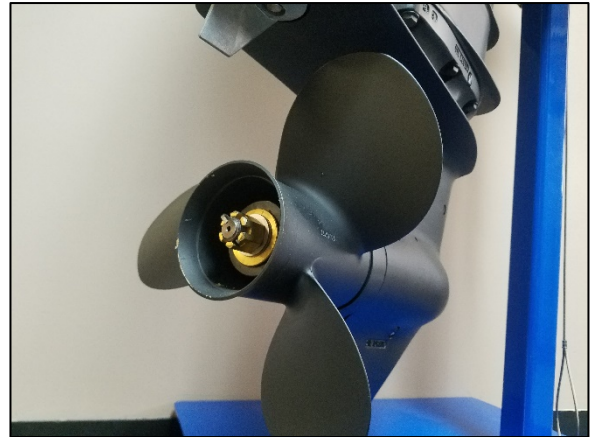

Anode Trim Tab

A fin shaped object attached behind the propeller that serves two functions. Functions as a zinc anode and counter acts the torque pressure generated by the propeller spin that makes steering more difficult.



Skeg

The lowest point on an outboard motor, improves directional stability. Protects the prop from impact. The angle of the skeg deflects the Gearcase from rocks and logs.



**FUEL REQUIREMENTS**

Gasoline is the primary and preferred fuel to be used when operating the Raider 40 HP. Use a major brand of automotive unleaded gasoline with a minimum posted octane rating of 91 RON. Automotive gasoline that contains fuel injector cleaner are preferred for added internal engine cleanliness. Leaded gasoline is acceptable in areas where unleaded gasoline is not available. When required, Heavy Fuels like JP-5/8; kerosene; Diesel maybe used.



**Use of low-quality gasoline results in a short engine life as well as starting difficulties and other engine problems. We recommend use for Fuel stabilizer.**



**Use of gasoline containing alcohol can cause engine starting and/or operating difficulties, wear of and damages to engine parts, and deterioration of chemical parts, which may lead to shortening of your outboard motor's life.**



Regardless of what fuel is utilized, the fuel must be mixed with a certified NMMA TC-W3 2-Cycle motor Oil. Raider Outboards provides a specially formulated TC-W3 developed by VP Racing. The Raider Outboards TC-W3 2-Cycle Outboard Synthetic Marine Oil is specifically designed to meet the lubrication requirements of a submersible engine.

Mix Ratios: Gasoline requires a 50:1 Fuel to Oil mixture. 16oz per six (6) gallons or about 2.5oz per every one (1) gallon. Heavy Fuel requires a 12:1 Raider Elixir mixture. One (1) can Raider Additive per six (6) gallon of fuel. 64oz per six (6) gallons or about 10.5oz per every one (1) gallon of fuel in addition to the 50:1 oil to fuel mixture.



When mixing fuel, pour the oil mixture into the bladder or tank first. If using Heavy Fuel add the elixir as well. Then add fuel. Shake the tank to mix engine oil and gasoline well and even. Annotate the date of the mixture. Fuel older than 90 days should be disposed of via required hazardous materials disposal instruction for your organization.

The only lubrication provided for the Raider Outboard Motor is through the oil added to the gasoline, therefor running with too little oil will cause engine damage. Oil burns differently than gasoline however, and running too much oil will make the engine run poorly, smoke excessively, foul spark plugs, and will even plug up the exhaust with oil residue. So, it is vital to both engine life and engine performance that you run the right mixture.



**Do not mix different brands of oil. Mixing different brands of oil, or different types of oil even if the brand is the same, may cause gelling, resulting in possible filter screen blockage. This could result in serious engine damage because of impaired lubrication performance.**



**Use of engine oils that do not meet certified NMMA TC-W3 2-Cycle motor Oil requirements will result in reduced engine life, and other engine problems.**

**HAZARDOUS MATERIAL REQUIREMENTS**

Marine Grease NLGI#2 GC/LB

Corrosion Zero

Isopropyl Alcohol Cleaning Solvent

Dielectric grease

Marine Lithium Grease

Loctite 243, Threadlocker

Battery Spray Protector, Permatex

thread locking compound, Loctite 272

Permatex, High tack gasket sealant

Loctite 242, Threadlocker

Lower Unit Gear Oil, API Grade GL-5, SAE 80W-90W

TC-W3 2-Cycle Outboard Synthetic Marine Oi

Silicone Spray

Anaerobic gasket maker

anti-seize

**BREAK-IN**

Your new outboard motor and lower unit require break-in for the moving components according to the conditions described in the following time table.

Fuel mix ratio for break-in: 25:1 Mix Ratios: 32oz of TC-W3 2-Cycle Outboard Synthetic Marine Oil per six (6) gallons of gasoline or about 5oz per every one (1) gallon.

|                          | 1-10min | 10min-2hrs             | 2-3hrs   | 3-10hrs  | After 10hrs             |
|--------------------------|---------|------------------------|--|--|-------------------------|
| <b>Throttle Position</b> | Idle    | Less than 1/2 throttle | Less than 3/4 throttle                           | 3/4 throttle   | Full throttle available |
| <b>Speed</b>             |         | Approx 3000 rpm max    | Full throttle run allowed for 1 min every 10 min | Approx. 4000 rpm. Full throttle run allowed for 2 min every 10 min |                         |



Operating the outboard motor without break-in can shorten service life of the product. If any abnormality is experienced during the break-in: Discontinue the operation immediately. Contact Raider Outboards Technical Support for action(s) if necessary.



Proper break-in allows outboard motor to deliver it full performance for longer service life.

## **STANDARD OPERATING PROCEDURES**

### **PRE AND POST OPERATIONS CHECKS**

As the Operator or Field Service Technician (FST) you must be intimately familiar with the Pre and Post Operations Checks for the Raider 40 HP Motor. Preparing the motor for an operational period is the most critical part of mission execution. These actions directly contribute to mission success and when ignored will lead to reduced reliability, motor casualties, or mission failure.

Pre-Operations Checks are developed and implemented for the express purpose of assessing the reliability of the motor prior to use, prepare the motor for use, and reduce failures of the motor during an operational cycle or mission.

Post Operations Checks are developed and implemented for the purpose of establishing a maintenance procedure to be conducted after each operational cycle or mission that mitigates operational stressors placed on the motor while in use, extends service life of the motor, and improves reliability of the motor.

Formal documentation provided by Raider Outboards that details the recommended procedures for placing the motor into and out of an operational cycle or mission.

The Pre and Post Operations Sheets allow Maintainers and Operators a written means to document prescribed preventative maintenance checks, document operational hours and accurately capture discrepancies.

For every operational cycle a record or log should be maintained under motor serial number that provide Maintainers, Operators, and Service Technicians with a history of the motor.

**PRE-OPERATIONS CHECKS**Exterior.

Inspect Cowling, Engine Pan, Midsection, and Lower Unit for cracks, defects, or damage.

Zinc Anodes.

Stern Brackett Anode. Replace if damaged or reduced in size by more than 40%. Trim Tab Anode. Replace if damaged or reduced in size by more than 40%.

Control Panel.

Inspect the Start and Stop controls. Verify the Lock Plate and Lanyard are installed. Inspect for damage due to corrosion, lack of maintenance, or abuse. Loose ball joints, locknuts, bent link rods, loose rod snaps.

Cable Lanyard.

Verify the Cable Lanyard is securely attached to the motor and maybe securely attached to craft Transom.

Shift Lever Mechanism and Shift Lever Stopper.

Inspect for damage due to corrosion, lack of maintenance, or abuse. Loose ball joints, locknuts, bent link rods, loose rod snaps.

Throttle Linkage.

Inspect for damage due to corrosion, lack of maintenance, or abuse. Loose ball joints, locknuts, bent link rods, loose rod snaps. Lubricate with low temperature lithium grease.

Tilt Stopper, Bracket Bolt, Bracket Shaft, Clamp Screw, and Reverse Lock.

Inspect for damage due to corrosion, lack of maintenance, or abuse. Lubricate with Friction Surface Marine Grease.

Hook Lever Mechanism (cowling).

Inspect for damage due to corrosion, lack of maintenance, or abuse. Lubricate with Friction Surface Marine Grease.

Recoil Starter.

Inspect for damage due to corrosion, lack of maintenance, or abuse. Lubricate with Friction Surface Marine Grease.

Starter Lock.

Inspect for damage due to corrosion, lack of maintenance, or abuse. Lubricate with Friction Surface Marine Grease.



**Battery.**

Inspect battery case for damage. Inspect cables for cracks, chaffing and insulation damage. Check battery mounting. Inspect battery connector for corrosion. Lubricate battery connector with dielectric grease.

**Electrical Wiring.**

Inspect wires for cracks, chaffing and insulation damage. Check for loose connections.

**Ignition Coil Plug Wire Boots.**

Prior to submersion, remove plug boots and fill with dielectric grease.

**Gearcase.**

Inspect water intake screens. Inspect the Skeg for damage.

**Propeller.**

Inspect and verify propeller is true and free of nicks, chips, and other damage that could affect performance. Propeller Shaft. Inspect for damage due to corrosion, lack of maintenance, or abuse. Inspect the shaft threads and splines for wear and damage.

**Gasoline Fuel Mix Ratio.**

Requires a 40:1 oil to fuel mixture. 16oz per six (6) gallons or about 2.5oz per every one (1) gallon. Use only NMMA TC-W3 2-Cycle motor Oil. Record date of mix, dispose of fuel mixtures older than 90 days. Lubricate with Friction Surface Marine Grease.

**Heavy Fuel Mix Ratio.**

Requires a 12:1 Raider Elixir mixture. One (1) can Raider Additive per six (6) gallon of fuel. 64oz per six (6) gallons or about 10.5oz per every one (1) gallon of fuel in addition to the 40:1 oil to fuel mixture. Use only NMMA TC-W3 2-Cycle motor Oil. Record date of mix, dispose of fuel mixtures older than 90 days.

**Full Tank/Bladder.**

Inspect for leaks: Ensure that the bladder is not leaking from any seam, fill cap, vent, or rip in membrane. Inspect securing straps: Ensure the bladder can be adequately secured to the deck. Inspect fuel line connector: Check for damage and ensure that the fuel line fitting properly mates. Inspect vent: Ensure the vent opens and shuts.

**Fuel Line Assembly.**

Inspect end connectors: Check ensuring proper fit and seal to bladder and Raider. Inspect fuel line: Check for dry rot and leaks. Inspect bulb: Check for proper installation, dry rot, and function. Stow extra Fuel Line Assembly in sponson bag or Emergency Kit.

**Heavy Fuel Block Valve.**

Ensure that the Heavy Fuel Block Selector Valve is lock wired in the shut position when using gasoline.

**Fuel Filter.**

Inspect component for leaks, damage, or excessive wear. Inspect Clamps: Ensuring proper fit, note leaks, damage, or excessive wear. Inspect Lines: Check for dry rot and chaffing.

**Fuel Pump.**

Inspect component for leaks, damage, or excessive wear. Inspect Clamps: Ensuring proper fit, note leaks, damage, or excessive wear. Inspect Lines: Check for dry rot and chaffing.

**Carburetors.**

Inspect component for leaks, damage, or excessive wear. Inspect Clamps: Ensuring proper fit, note leaks, damage, or excessive wear. Inspect Lines: Check for dry rot and chaffing.

**Primer.**

Inspect for damage due to corrosion, lack of maintenance, or abuse. Loose ball joints, locknuts, bent link rods, loose rod snaps. Lubricate with Friction Surface Marine Grease.

**OPERATIONAL CHECKS***Pull Start.*

Start the motor using the Recoil Starter.

*Electric Start.*

Start the motor using the Electric Start Push Button.

*Neutral Safety.*

Verify that the motor will not start in gear both forward and reverse.

*Water discharge from check ports.*

When the motor is running verify that water is being discharged from all check ports.

*Tiller Steering.*

When moving the Tiller Arm, verify that the motor moves freely to port and starboard.

*Neutral.*

Verify the propeller does not engage when the gear selector is in the neutral position.

*Forward.*

With the motor at idle, verify the Gear Selector moves freely into the forward position and the propeller engages.

*Reverse.*

With the motor at idle, verify the Gear Selector moves freely into the reverse position and the propeller engages.

*Throttle Control.*

With the engine in neutral, slowly increase the throttle RPM's to approximately.

*Emergency Stop Switch.*

While the motor is running, remove the lock plate, the motor should stop.

*Engine Stop Switch.*

While the motor is running, press the Engine Stop Switch, the motor should stop.

*Shallow Water Running.*

Move the motor Reverse Lock Lever to the release position, lift the lower unit past a 45° angle until the tilt stopper assembly locks.

Full Tilt Position.

Move the motor Reverse Lock Lever to the release position, lift the Lower Unit past a 90° angle until the tilt stopper assembly locks.

**POST OPERATIONS CHECKS****Fresh water wash-down. (Salt-Away is recommended).**

Wash the exterior of the motor with fresh water. Remove the motor cowling and fresh water wash the powerhead. After submersion period ensure fresh water is forced under the flywheel and Recoil Starter. After submersion full extend the Recoil Starter Line/Rope and wash with fresh water.

**Fresh water motor flush.**

Attach "ears or flush connector" to lower unit. Operate the engine for approximately five (5) minutes at full operating temperature. After a submersion period the motor must be run at operating temperature for no less than 30 minutes to ensure all water is removed from the head. Disconnect the fuel supply and let the motor run itself dry.

**Wipe Down.**

Use LP air or dry cloth to remove excess water from exterior and interior surfaces of the motor. After submersion use LP air to remove water and moisture under the Flywheel and Recoil Starter.

**Corrosion Prevention.**

Spray the Powerhead with a liberal coat of Anti-Corrosion Spray penetrant/lubricant or equivalent. Spray 6 & 1 Penetrating Lubricant or equivalent under the flywheel.

**Battery Maintenance.**

Unplug or remove battery – place on battery tender to maintain charge.

**Air Dry.**

Leave the upper cover off, when possible to allow the powerhead and other components to air dry.

MOTOR MOUNTING



**Do not operate the outboard motor until it has been securely mounted on the boat in accordance with the instructions below.**

Position the outboard motor at the exact center of the transom. Use the hand-tightened screw thread clamps. These clamp the transom of the craft between the motor stern bracket and the screw thread plates.

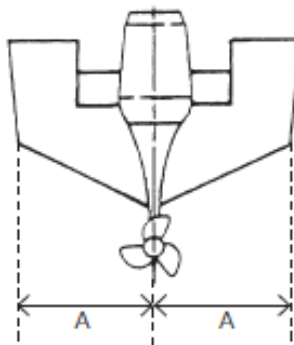

Attach safety cable (lanyard) to secure the motor to the craft and prevent the motor from dropping from the stern if the clamps get loose or fail during operation.

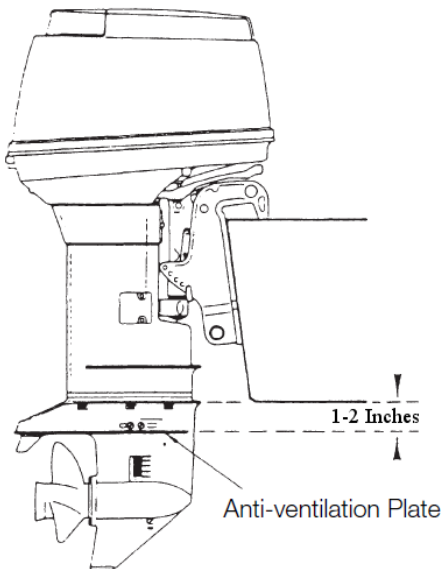

When installed the Anti-ventilation Plate should be just below the bottom of the boat approximately 1-2 inches. Be sure that the anti-ventilation plate of the outboard is below the water surface when running with wide open throttle. If the water is being pushed into the craft; raise the motor on the transom by adding a shim on top of transom to achieve proper motor height.

Attaching the Stern Bracket. Both Zodiac and Wing inflatables should come with a transom plate attached. These plates provide a guide for the stern bracket of the motor that will automatically center the Raider 40 to the center line of the craft. Then simply tighten the stern bracket screws.

After 10-15 minutes of operation recheck the stern clamp screws for tightness.



**Overheating may occur if the Anti-ventilation Plate is at a level higher than the bottom of the boat, as a result of a lack of cooling water.**

**PROPELLER SELECTION**

A propeller must be selected so that the engine rpm measured at wide open throttle while cruising is within the max. operating range; 5,140 to 5,840 rpm.

|  | Mark | Propeller Size (Diameter Pitch) |         |
|--|------|---------------------------------|---------|
|  |      | Inch                            | mm      |
| <div style="text-align: center;"> <p><b>Heavier Load</b></p>  <p><b>Lighter Load</b></p> </div> | 7*   | 11.4x7.1                        | 290x180 |
|  | 8.5  | 11.2X8.7                        | 285X220 |
|  | 9    | 10.9X8.9                        | 276X226 |
|  | 10   | 10.8X9.9                        | 275X252 |
|  | 11   | 10.6X11.3                       | 268X287 |
|  | 12   | 10.6X11.7                       | 268X296 |
|  | 13   | 10.3X12.7                       | 262X322 |
|  | 14   | 10.2X13.9                       | 260X352 |

\*Indicates a four (4) blade propeller

The pitch of a propeller is defined as "the distance a propeller would move in one revolution if it were moving through a soft solid, like a screw through wood." For example, a 15-pitch propeller would move forward 15 inches in one revolution.

The lower the prop pitch, the better your hole-shot. However, this comes at a price: top speed. The lower pitch makes the engine reach maximum rpm at slower speeds. Conversely, a higher pitch will deliver greater top speeds, but slower acceleration.

If you're changing pitch, remember that each inch of pitch is worth about 200 rpm. Lowering the pitch will increase rpm and vice versa. For example, going from a 11-pitch to a 13-pitch propeller will increase engine rpm by about 400 revolutions.

The trick is to choose a propeller that delivers acceptable acceleration and top speed. Perhaps what's most important is your performance goals, either deliver low-end torque or faster top speeds, you can't have both. If you load your boat with tons of gear, you might need a low pitch. If you need more speed, a higher pitch is the way to go.

**STARTING THE RAIDER 40 HP**

The primary means to start the motor is by using the recoil starter. The recoil starter is mounted to the top of the powerhead with the T-Handle pull cord grip fed through the opening in the forward part of the motor cowling. A mechanical safety mechanism prevents the motor from starting unless the gear select lever is in the neutral position.

The secondary means to start the motor is by using the engine start push button. This button is located on the front portion of the lower engine cover. When pressed it engages the starter motor to start the engine. This method of starting is normally used when under duress or prevailing conditions prevent motor start by the primary method.

The tertiary means to start the motor is used only when the primary and secondary have failed. The engine cowling is removed to gain access to the Recoil Starter. Using tools provided in the Emergency Tool Kit, the recoil starter is removed. Using the cord provided in the Emergency Tool kit, wrap it around the starter pulley. When the cord is fully wrapped around the starter pulley, simply pull the end to start. When using this method, the motor will start in gear.

**Starting Procedure.**

- 
1. Ensure dewatering lever is fully forward and locked into position.

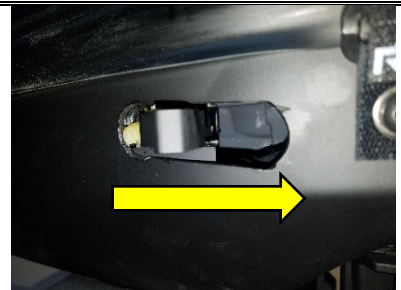

- 
2. Install the safety lock in the stop switch (lanyard).

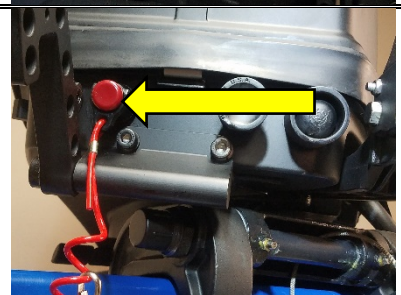

- 
3. Connect the fuel connector to the engine





4. Feed fuel to the carburetor by squeezing the primer bulb until firm.



5. Pump the Primer Valve two or three times.

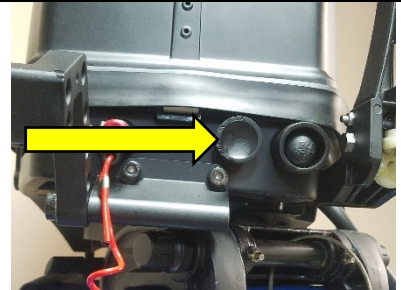

6. Set the shift lever to Neutral



7. Turn the throttle grip so that the indicator line meets the "START" mark.



8. Pull the starter rope slowly until resistance is met. Give it a sharp tug to start the engine. Electric start button can be used to start engine if user desires.



9. Turn the handle grip to its original position gradually once the engine has started. Confirm that cooling water is being discharged from the check port and idle port.



10. Carefully turn the throttle grip to "SLOW".

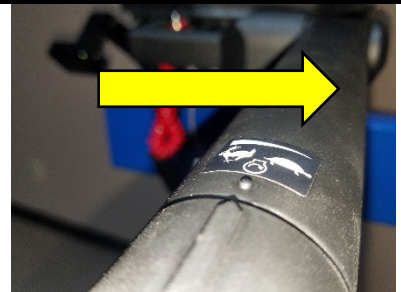

11. Let the motor run at idle for approximately three minutes for warm up prior to placing under load. This will ensure all moving surface are at optimal operating temperature and properly lubricated. Immediately placing under load after start will significantly shorten motor life.



 **WARNING**

- Do not operate the engine with gear case out of water. Severe personal injury, or engine damage will result.
- Be careful that your clothes or other items do not get caught in the rotating engine parts.
- To prevent accident and injury, do not reattach the recoil starter after the engine has been started using the emergency starter rope. Be sure to put the top cowl back on.
- Do not operate the outboard motor with top cowl removed from the power unit, or contacting turning flywheel which can lead to serious personal injury.

 **CAUTION**

- Be sure to warm up engine well before starting cruise. Operating cold engine can give damage to it.
- Be sure to stop engine immediately if cooling water check port is not discharging water, and check if cooling water intake is blocked. Operating engine could lead to overheating potentially leading to engine damage. Consult an authorized dealer if the cause cannot be found.
- Do not shift to "F" or "R" until turning into proper idle speed.

**MANEUVERING**

Idle. Proper idle speed after warm-up operation. Clutch in (In gear) 740 RPM, Clutch off (Out of gear) 900 RPM.

Accelerating. Twist the throttle grip on the end of the steering tiller inboard to accelerate. Do not exceed the full-throttle engine speed. Wide-open throttle (WOT) RPM range 5,140 - 5,840rpm.

Shifting. Prior to shifting between forward and reverse, ensure that the motor is brought to idle, the place the motor into gear.

Turning. the tiller is always moved in the direction opposite of which the bow of the boat is to move. If the tiller is moved to port side (left), the bow will turn to starboard (right). If the tiller is moved to starboard (right), the bow will turn port (left).

Stopping. Bring the motor to idle speed and place the gear shift lever in the neutral position. Secure craft to pier if required. Press the engine stop switch.

Reversing. Turn the throttle grip toward "SLOW" and move the Shift Lever quickly to Reverse when the engine speed has reached the lowest RPM. Ensure the Tilt Lever is in the locked position (fully up). If not, when engaged the propeller will climb out of the water.

Ensure that the Lock Plate Lanyard is attached to some point on your body, in the event of falling overboard. The engine will shut down when the switch lock becomes disconnected from the engine.



- **Never stop the engine immediately after a full throttle run. Keep it running for two or three minutes at idling speed (Shift Lever set to Neutral) to allow it to cool down.**
- **Before moving the Shift Lever to Reverse, make sure the Reverse Lock is engaged (in up position).**
- **Do not increase the engine speed unnecessarily while reversing.**
- **The Shift Lever cannot be turned from Neutral to Reverse unless the throttle grip has been turned fully toward "SLOW"**

**TRIM ADJUSTMENTS**

By changing the outboard motor's drive angle, the vessel's bow can be made to rise or fall. The performance and stability of a vessel depends a great deal on correctly trimming the motor. The correct trim angle depends on the vessel's handling characteristics, the sea and loading conditions. Care must therefore be taken to ensure the outboard is trimmed correctly under different sea and loading conditions.

Proper Trim Angle. The trim angle is optimum when the craft is parallel to the water surface while running. Physically lift the motor, remove the thrust rod from series of holes in the stern bracket and re-adjust it higher or lower. Either alters the angle thrust from the propeller is delivered, relative to the water surface and the craft, and the attitude (or trim,) of the craft to the water accordingly.

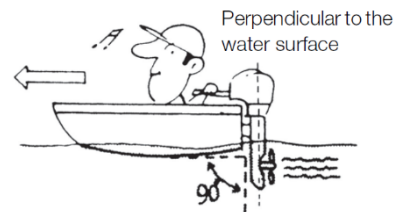

Trimming Out Excessively (bow rises too high) If the trim angle is set too far out, the bow will rise out of the water and the speed will decrease. Furthermore, the bow may sway or the bottom may slam the water while cruising. In this case decrease the trim angle by setting the thrust rod in a lower hole.



Trimming In Excessively (bow sinks or broaches) If the trim angle is set too far in, the bow will sink or plunge into the water decreasing speed and swamping your craft. Moreover, as the bow buries into a wave, the resistance created when hitting the wave causes the bow to dig into the water and the craft to veer sharply off course. Craft control is lost, passengers are thrown around, and this can even result in capsizing. In this case increase the trim angle by setting the thrust rod in a higher hole.



In general, the Raider 40 HP trim should be set to the second hole from the bottom. However, this does not preclude the Operator from assessing load and prevailing sea conditions and adjusting the Trim setting accordingly.

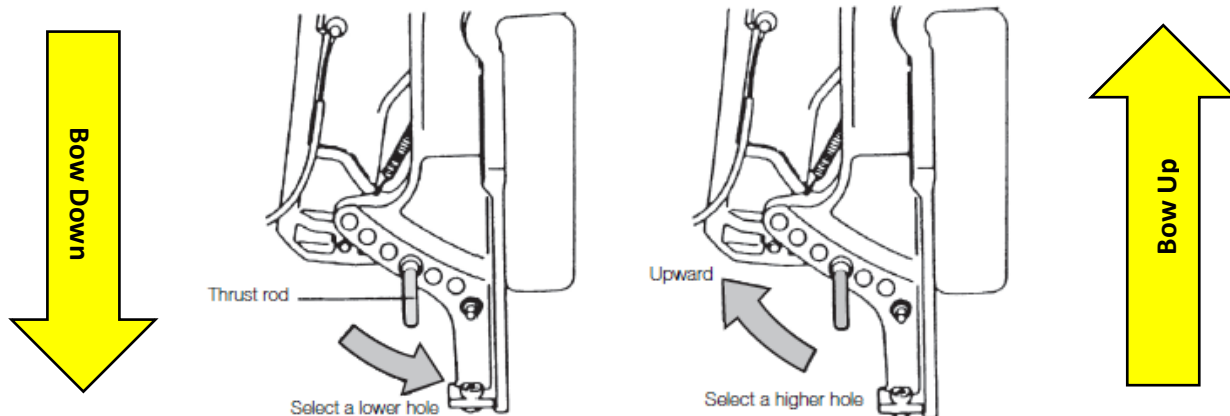



Excessive trim up or down may lead to unstable boat operation, potentially causing the steering difficulty that leads to accident during cruising. When testing a trim position, run boat slow initially to see if it can be controlled safely.

- Do not put hand or finger in between outboard motor body and clamp bracket when adjusting trim angle to prevent injury in case the outboard motor body falls.
- Unsuitable trim position can cause loss of control of boat.
- Do not cruise at high speed if improper trim position is suspected. Stop the boat and readjust trim angle before continuing cruise.
- For outboard motor model with PTT switch on the bottom cowl, do not operate the switch during cruising, or control of boat may be lost.



**SHALLOW WATER RUNNING/BEACHING**

Place the engine in a modified-up position, nearly at 45 degrees to allow for operations through shallow waters or beaching, where the lower unit may inadvertently contact the bottom.

Set the Reverse Lock Lever on the starboard side of the engine swivel mount to "Release" by placing it in the fully downward position.

Tilt the engine up approximately to 45 ° and lower it on the tilt stop.



Ensure the water intakes are below the waterline, failure to do so will cause the motor to overheat and fail.

When operating reverse propulsion, do not accelerate rapidly. Rapid acceleration will cause the propeller to climb out of the water and may dislodge from the transom or injure personnel.



**During shallow water operation, be careful not to place your hand between the swivel bracket and the stern bracket. Be sure to tilt the outboard down slowly.**

- **Run at lowest possible speed during cruising using shallow water drive.**
- **Tilt lock is disabled when in shallow water drive position.**
- **When driving shallow water, be careful not to strike outboard motor against sea bottom, or propeller may be pushed out of water, resulting in loss of control.**



**While in shallow water drive position, do not operate the outboard in reverse. Operate the outboard at slow speed and keep the cooling water intake submerged.**

### DEWATERING

The Raider 40 HP upon recovery to the surface may be fully operational within 10 minutes. Easy instructions for dewatering are provided affixed to the cowling of every outboard motor. Most Operators, with practice and adherence to the provided instructions, restore the motor to operations within two (2) minutes of surfacing. Skilled operators are able to achieve lite off in as few as 30 seconds.

The ability to submerge, without bagging, and quickly start is achieved by actuating a lever that opens valves in the cylinder head and fuel system that allows water to quickly be dispelled from the motor. Using the recoil starter, the Operator slowly pulls the motor over several times forcing water from the head by movement of the pistons while simultaneously using the fuel line primer bulb to expel bad fuel from the fuel system through the Dewatering Valve.

#### Pre Submersion

- To prevent water intrusion on electronics during submersion. Make sure the inside of all electrical connectors are coated with dielectric grease and firmly connected.
- Ensure the Dewatering Lever is locked forward (shut).
- Ensure battery is fully charged and re-connected correctly.
- Ensure fuel bladder is fully filled with 40:1 oil mix and cap tightened.
- Connect fuel line and pump primer bulb until firm resistance is felt to fill fuel system.

#### Dewatering Procedure

- Secure the motor in the run position
- Remove the safety lanyard, and place the shift lever in **NEUTRAL** position.
- Open the Dewatering Valve (slide Dewatering Lever towards the back of motor)
- Slowly pull the Recoil Starter ten (10) times. (until water is cleared from the system)
- Ensure the fuel line is connected and squeeze the Primer Bulb until water clears from fuel line overboard.
- If equipped with electric start function, push and hold the starter for a minimum of four (4) seconds
- Close the Dewatering Valve (slide Dewatering Lever fully forward and into the locked position)
- Squeeze the Primer Bulb until it is firm
- Pump the motor Primer 5 times
- Turn the throttle 1/2-inch past normal start position
- Reinsert the safety lanyard.
- Start motor
- If engine fails to start pump primer three (3) more times
- Start Motor
- Repeat Procedure

Post Submersion

- Whenever possible after submersion in sea water, upon completion of operational period, wash entire engine and powerhead with fresh water to remove salt deposits, especially under the Recoil Starter and Flywheel where the accumulation of deposits will build up. Raider recommends that your organization use Salt-Away when conducting post submersion maintenance. Salt-Away is a water-based, non-hazardous, biodegradable solution and contains properties that dissolve, release and remove salt crystals from any surface. Works to protect against salt corrosion and reduces costly unforeseen maintenance actions caused by salt. Salt-Away breaks apart and removes salt accumulation with repeated use.
- After submersion and operation, if the Raider cannot be immediately serviced, keep it submersed or re-submerge the motor until time is sufficient that it may be serviced. Avoid prolonged exposure to the atmosphere. If possible, submerge in fresh water but even prolonged salt water submersion is preferable over exposure of an unserviced motor to the atmosphere. When operations are concluded, simply recover the motor and Dewater following the Dewatering Procedures and proceed with service.
- After submersion period it is critical that the motor must be run at operating temperature for no less than 30-minutes to ensure all water is removed from the head. Raider recommends that your organization use STA-BIL 360 Marine treated fuel during this run period. STA-BIL 360 Marine provides enhanced water removal properties to prevent fuel system corrosion. Engineered specially for the harsh coastal climates, prevents corrosion, cleans the fuel system and prevents the buildup of unwanted gum and varnish; mitigating the adverse effects of submerging your Raider 40 HP.
- After the 30-minute run period, disconnect the fuel supply with the motor running and let the motor run itself dry.
- Using LP air, if available remove excess water from the surfaces of the powerhead. Force air under the recoil starter and flywheel. If LP air is not available, use shop towels or rags to remove excess water.
- Spray the entire power head with a liberal coat of Anti-Corrosion Spray penetrate/lubricant or equivalent. Raider recommends that your organization use Corrosion Zero, a special corrosion preventative compound that prevents deterioration and contamination of all surfaces of electronic equipment and mechanical close-tolerance components. This corrosion inhibitor contains extremely long-lasting, specially formulated and proprietary anti-corrosive inhibitors that provide a superior lubrication coefficient. Corrosion Zero film remains flexible and will not crack when the treated material is subject to vibration and/or thermal expansion or contraction. It is the flexibility of the film that makes Corrosion Zero extremely effective against fretting corrosion. Also, because the film is not rigid, the film tends to be "self-healing" and will fill scratches that are caused by the mating and/or unmating of close tolerance parts.



- Leave the upper cover off, when possible to allow the power head and other components to air dry.
- Unplug or remove battery – place on battery tender to maintain charge.

**EMERGENCY (TERTIARY) STARTING**

In the event of failure of both the Recoil Starter and the Electric Start function the Raider may be started using a tertiary or emergency starting method. Using the items provided in the Emergency Tool Kit (ETK) follow the following steps.

- Remove the motor cowl and secure it in the craft.
- Using the 10mm socket and driver, remove the two (2) 10mm bolts/washers and one (1) 13mm bolt/washer that secure the recoil starter over the starter pulley and flywheel.
- Remove the retention clip from the Neutral Safety/Starter Lock and stow the Recoil Starter.
- Using the cord from the ETK tie a knot in one end.
- Wind the cord around the flywheel and use a socket. Use a socket wrench or similar to get a firm grip on the end of the rope.
- Give it a sharp tug to start the engine.

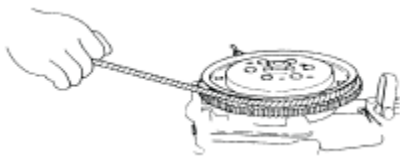
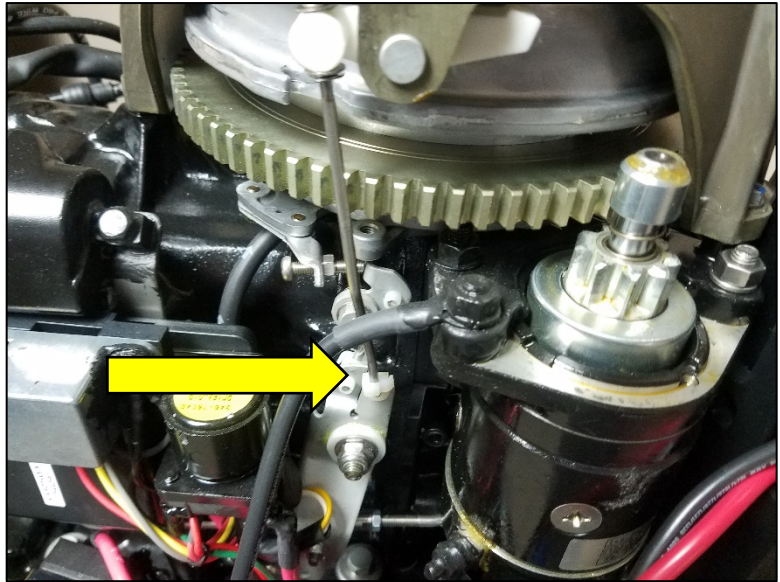

**Be careful that your clothes or other items do not get caught in the rotating engine parts. To prevent accident and injury, do not reattach the recoil starter after the engine has been started using the emergency starter rope. Be sure to put the top cowl back on.**

### MAINTENANCE REQUIREMENTS

Pre and Post Operations Checks should be conducted prior to and after each operational period. These checks are described in detail in Section 2 of this manual. For your organization's convenience the Pre and Post Operations Sheets are included in the appendices in this manual.

|                   | Item                 | Servicing Interval |        |         |        |        | Inspection Item                                   |
|-------------------|----------------------|--------------------|--------|---------|--------|--------|---|
|                   |                      | 25 Hrs             | 40 Hrs | 100 Hrs | 1 year | 2 year |   |
| Fuel System       | Carburetor           | •                  |        | •       | •      | •      | clean, inspect, adjust idling                     |
|                   | Fuel Filter          | •                  | •      | •       | •      | •      | clean, inspect                                    |
|                   | Fuel Lines           | •                  | •      | •       | •      | •      | routing, material condition, connectors           |
|                   | Heavy Fuel Block     | •                  | •      | •       | •      | •      | lock wire, material condition, connectors         |
|                   | Primer               | •                  | •      | •       | •      | •      | material condition                                |
|                   | Dongle               | •                  | •      | •       | •      | •      | material condition, connectors                    |
| Ignition          | Spark Plugs          | •                  | •      | •       | •      | •      | clean, inspect, gap check                         |
|                   | Ignition Coils       | •                  | •      | •       | •      | •      | clean, inspect, grease                            |
| Starting System   | Starter Rope         | •                  | •      | •       | •      | •      | material condition                                |
|                   | Starter Motor        |                    |        |         | •      | •      | disassembly, cleaning and inspection              |
| Engine            | Compression Test     |                    |        |         | •      | •      | 155 psi +/- 10%                                   |
|                   | Flywheel             |                    | •      | •       | •      | •      | clean, inspect                                    |
|                   | Coil Plate           |                    | •      | •       | •      | •      | clean, inspect                                    |
| Dewatering System | Decompression Valves | •                  | •      | •       | •      | •      | clean, inspect, torque 12ftlbs                    |
|                   | Dewatering Valve     | •                  | •      | •       | •      | •      | clean, inspect                                    |
| Lower Unit        | Propeller            | •                  | •      | •       | •      | •      | inspect   |
|                   | Propeller Shaft      | •                  | •      | •       | •      | •      | clean, inspect                                    |
|                   | Gear Oil             | •                  |        | •       | •      | •      | replace   |
|                   | Water Pump           |                    |        | •       | •      | •      | impeller and liner material condition             |
| Other             | Thermostat           |                    |        | •       | •      | •      | foreign substance in the gap, defective operation |
|                   | Bolts and Nuts       | •                  | •      |         | •      | •      | retighten   |
|                   | Grease Nipple        | •                  | •      | •       | •      | •      | greasing  |
|                   | Anodes               |                    |        | •       | •      | •      | clean, inspect                                    |

### TACH/HOUR METER

Monitors motor RPM while operating, tracks and displays Total Operating Time (TOT) for the purpose of scheduling and adherence to service intervals as recommended in this section. More stringent intervals may be required based on multiple submersions, heavy fuel use, operating conditions or personal experience.

Operational menu's may be cycled through by pressing the select button. Press and hold the select button to initiate a change within each menu. When menu header begins to flash, the select button is used to enter desired setting. Once input is complete, the unit will return to default display setting after a few seconds.

#### Timing System

- TOT: Accumulates motor total hours, non-resettable
- JOB: Records partial motor operating time, resettable
- SVC: May be set between 5- and 50-Hours countdown based on user requirements or service intervals. When time is reduced to zero 0.0 "SVC" will flash, indicating required service action. Default setting is 5 hours.
- SVC2: May be set between 10- and 250-Hours countdown based on user requirements or service intervals. When time is reduced to zero 0.0 "SVC2" will flash, indicating required service action. Default setting is 10 hours.

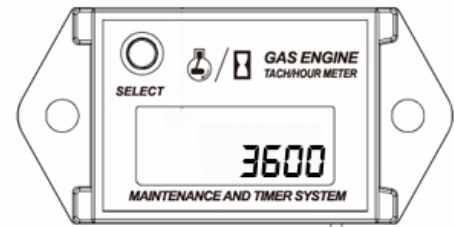
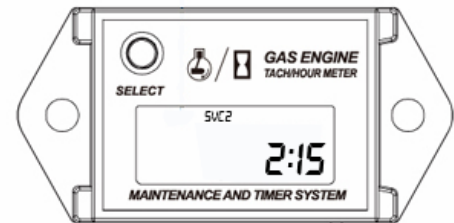
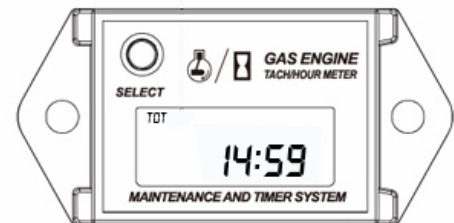

#### Real – Time Display

- RPM: When the motor is started the LCD, real-time display will indicate motor RPM.
- MAX RPM: Will record motors maximum RPM within an operational cycle. When motor is secured the MAX RPM may be viewed at any time. When the motor enters the next operational cycle, the previous reading will be replaced.

#### Engine Type Setting

- Factory setting is 4P1r

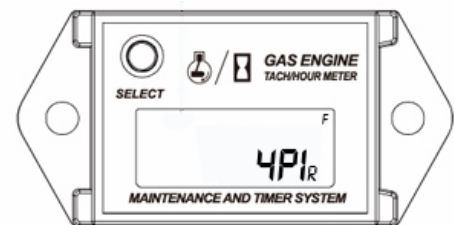

### SPARK PLUGS

Proper maintenance is essential to extending spark plug life. Careful reconditioning allows spark plugs to be reused at a far lower cost than replacement. Adhere to a scheduled service interval as recommended in this section. More stringent intervals may be required based on multiple submersions, heavy fuel use, operating conditions or personal experience.

#### Removal

- Prior to removing spark plugs for inspection and servicing, examine the area surrounding each spark plug for damage or missing components that may or contribute to or potentially lead to degraded performance.
- Carefully pull each plug boot connector straight out. Avoid side pressure, which may damage the terminal sleeve or the barrel insulator.
- Examine the Boot Extensions, replace cracked, arc tracked, or otherwise damaged.
- Visually inspect the boot and ignition contact for evidence of arcing or other damage.
- Remove each spark plug with a 16mm deep well socket. Carefully seat the wrench securely on the plug to avoid damage to the threads or barrel.



**Never install a spark plug that has been dropped (even if there is no visible sign of damage). Dispose of the dropped spark plug and replace it with new.**

#### Inspection

- Visually inspect. Dispose of plugs with worn, damaged, or cracked, Terminal Ends, Insulators, threads, electrodes, or other parts.
- Optimal, indicated by a brownish or caramel color on the porcelain firing end with few deposits. Electrode is slightly worn, but not eroded or burned.
- Lean, indicated by a dry whiteish texture on the porcelain firing end. In the worst cases the tip of the plug starts melting away.
- Rich/Oil, indicated by dark discolored porcelain, oil spillage on the tip of the plug. Also, the spark plug might be slightly wet on its thread.



### Cleaning

- Use a small piece of Emory cloth to clean the dark carbon coating off the plug by rubbing it against the center electrode and the side electrode.
- Brake cleaner may be use to remove grease and excess oil.
- If necessary, use a wire brush to remove buildup trapped within the threads.
- Wipe the plug down thoroughly with a rag after cleaning to remove all of the residue.

### Gap Check

- The optimal gap for the spark plug is (.035 in)
- Insert a gap tool into the space between the spark plug's body and the electrode that sticks out of it. Use the tool to measure the gap, then either pry the electrode further from the body to increase the gap or press it closer to the body to decrease it until the gap matches.
- Gap Tool is included with the Raider Outboards Maintenance Tool Kit.

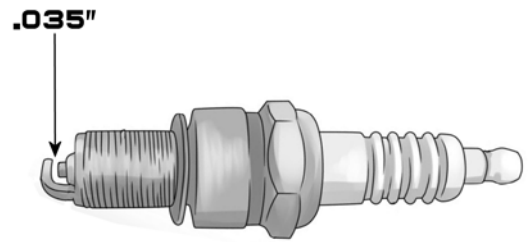

### Install

- Install spark plug, fully hand-tighten, and then use 16mm deep well socket to tighten to torque (20 lb ft).
- If a torque-wrench is not available when you are fitting a spark plug, a good estimate of the correct torque is 1/4 to 1/2 a turn past finger-tight. Have the spark plug adjusted to the correct torque as soon as possible with a torque-wrench to specified torque.

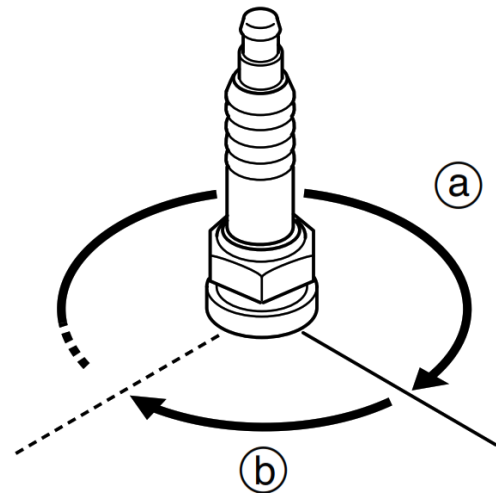

**CARBURETOR TUNING**

The Raider Outboards 40 HP is delivered with the carburetor pre-tuned from the factory. However, additional fine adjustment may be required to achieve optimum motor performance based on environmental factors, fuel supply, or Operator preference.

The Idle Mixture Set Screw is set from the factory to 1 ¼ turns 'out' and should not be adjusted further. Over time or through various operational cycles this setting may be changed. Adhere to a scheduled service interval as recommended in this section. More stringent intervals may be required based on multiple submersions, heavy fuel use, operating conditions or personal experience.

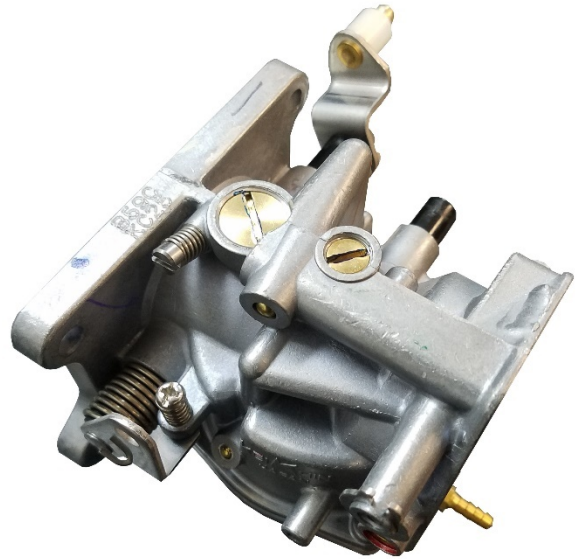

**Running the motor with the idle mixture set higher (more fuel) will cause the motor to burn too much fuel, resulting in loss of power, worsened fuel economy, and internal carbon buildup which can lead to further loss of power, increased maintenance, and eventual motor damage.**



**Running the motor with the idle mixture set too lean (less fuel) will result in insufficient lubrication of the motor's internal components and will cause damage to the motor.**

**Idle Mix Set Screw Reset**

- Slowly turn the set screw clockwise. Stop as soon as resistance is met. Tightening the set screw will result in damage to the carburetor.
- Slowly turn the set screw 1 ¼ turns counter-clockwise.
- The Idle Speed Adjustment Screw is set from the factory so that the engine idles between 1,000 and 1,100 RPM in neutral. Differences in atmospheric conditions, such as temperature, humidity, or altitude, will cause the engine to idle at different speeds.

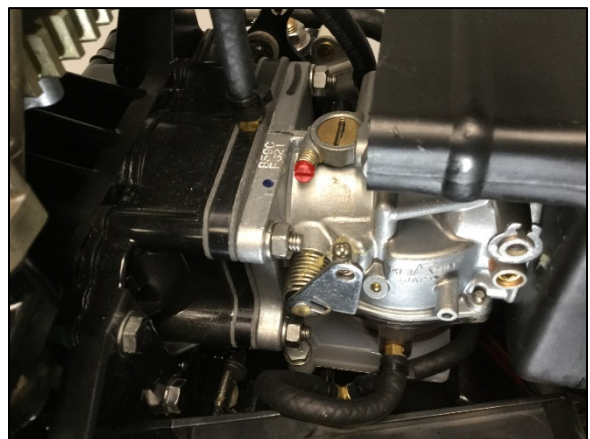

(Idle Mix Set Screw shown in red)

Setting idle speed

- To achieve factory idle speed, start the motor and allow to run at idle for four (4) to five (5) minutes.
- Adjust the Idle Speed Screw in very small increments, 1/8 - 1/16 turn at a time.
- Observe the engine RPM.
- If the idle is too low, turn the screw clockwise to raise engine RPM.
- If the idle is too high, turn the screw counter-clockwise to lower engine RPM.
- After making an adjustment, rev the motor by turning the throttle until engine RPM climbs, then quickly return the throttle to idle.
- Wait for the engine RPM to settle before continuing.
- Repeat this procedure until the engine idles between 1,000 and 1,100 RPM.

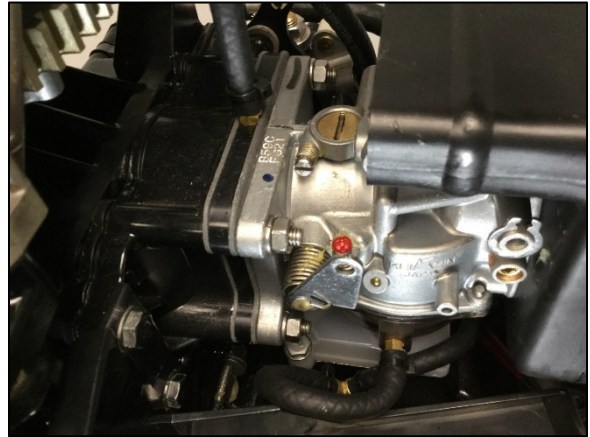

(Idle Speed Adjustment Screw shown in red)



**TIMING**

Timing is set by adjusting the Ball Joint Connector and Nut located on the Advancer Link Rod. The Ball Joint Connector attaches to the Ball Joint on the underside of the Coil Plate Assembly. Timing is measured in degrees with the scale located on the Coil Plate Assembly. The scale markings indicate 5° increments, beginning with -10° and ending with 25°. The measurement is read from the scale at the point where the seam (fitting line) of the crank case and block coincide. To make adjustments, remove the Ball Joint Connector from the Coil Plate. Adjust the length of the Advancer Link Rod so that the ignition timing match mark lines up with the fitting line of the crankcase and block and lock it with a nut.

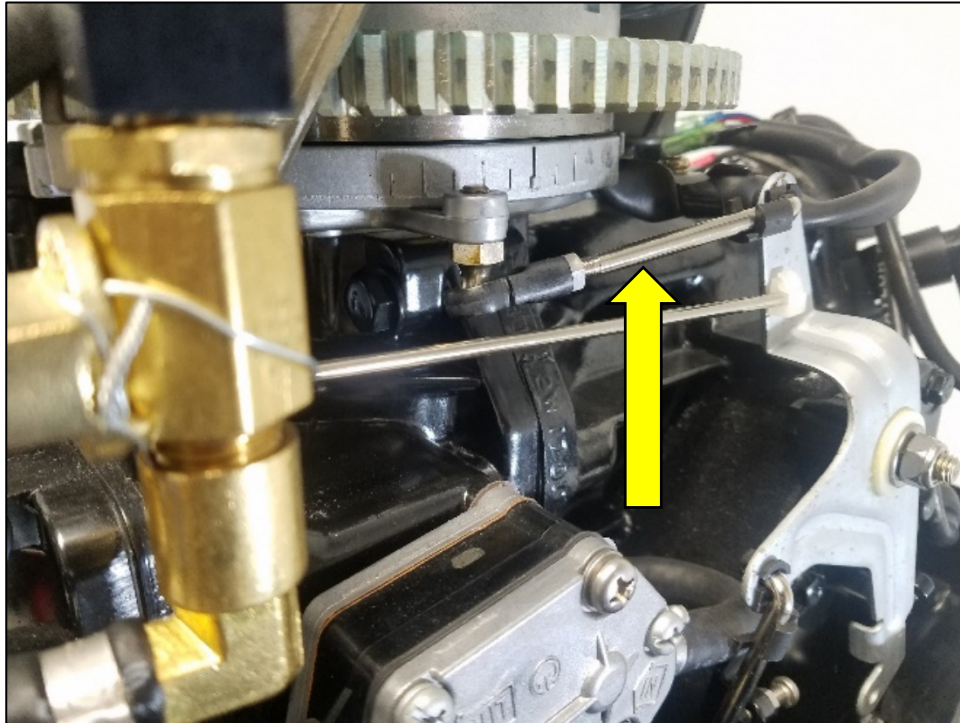
Timing Settings

- B.T.D.C.: Turn the throttle grip to the fully open position. Verify the timing match mark is (22°) +/- 2° with the fitting line of the crankcase and block, adjust as required.
- A.T.D.C.: Turn the throttle grip to the fully closed position. Confirm that the ignition timing match mark is (0°) +/-2° with the fitting line of the crankcase and block, adjust as required.

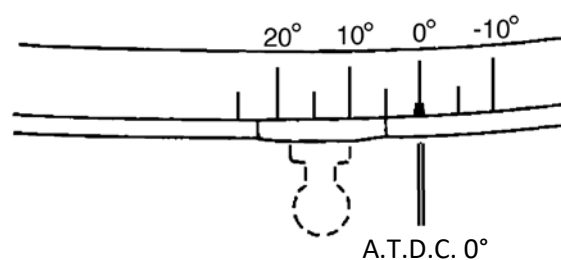
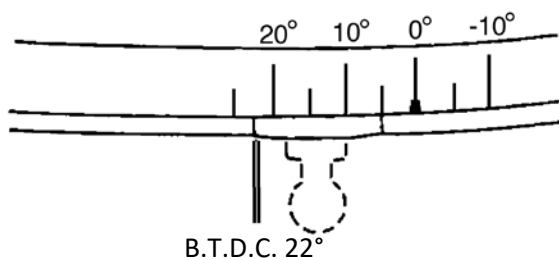

### CYLINDER COMPRESSION TEST

Compression tests are often done to determine the condition of the motor's internal components. If the motor isn't running as well as it should, the test may indicate that components are beginning to wear out. Unusual reading is a good indication that the motor may be required to be placed out of the operational cycle for depot level service.

#### Preparation

- Bring the motor up to operating temperature and secure.
- Disconnect the fuel source.
- Remove the lock plate lanyard and stow.
- Remove the spark plug from the cylinder to be test IAW the procedures contained in this section.

#### Performing the Test

- Attach the compression test adapter into the cylinder to be tested and connect the compression gauge to the opposite end of the hose.

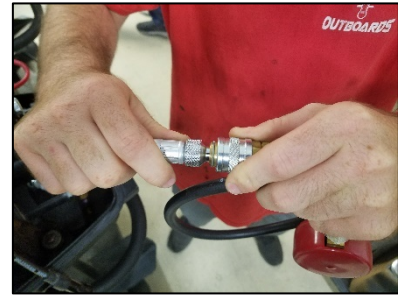
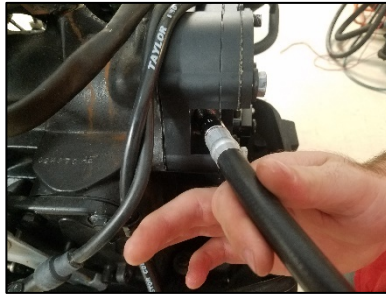
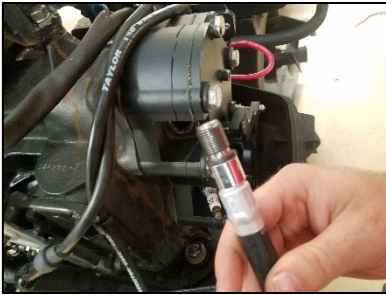

- Continually pull the recoil starter over until the needle on the compression gauge does not move to complete the test.
- The needle on the gauge should indicate >155 PSI.

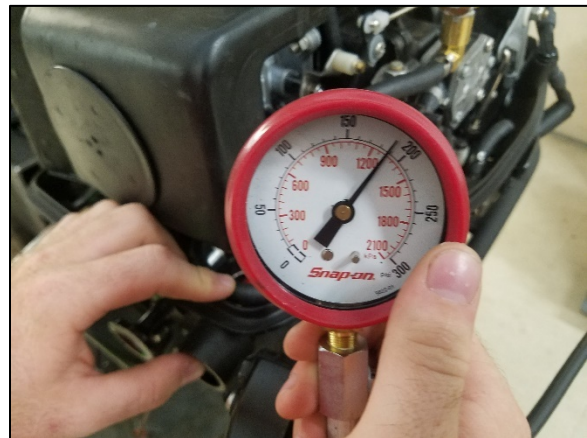

- Remove the test equipment and reinstall the spark plug IAW the procedures contained in this section.
- Repeat the testing process on the remaining cylinder.
- The difference across cylinders should not exceed 15 PSI.

*Interpreting the Test Results*

- If compression is below 155 PSI in one or more cylinders, the motor should be returned to the factory for depot level service.

**GEAR OIL CHANGE**

Synthetic API GL5, SAE#80 to #90 Gear Oil is a lubricant made specifically for transmissions, transfer cases, and differentials. It is of a higher viscosity than motor oil to better protect the gears and is usually associated with a strong sulfur smell. Adhere to a scheduled service interval as recommended in this section. More stringent intervals may be required based on Inadvertent contact with a submerged object, grounding or beaching, operating conditions or personal experience.

**Oil Change Procedure**

- First, be sure your outboard is in a vertical and upright position. Locate and identify the upper and lower Fill & Drain Plugs. Place an oil drain pan beneath the outboard.
- Remove the BOTTOM drain plug first (not the top). Some oil will begin to trickle out so be sure your oil drain pan is positioned correctly to catch the draining oil.
- Next, remove the TOP drain plug. This will release the vacuum that exists and allow the oil to drain freely from the lower unit.
- Let all of the oil drain completely from the lower unit. This will take about 5-10 minutes.
- Once all the oil has completely drained out it is time to refill the lower unit. To refill the lower unit, insert the bottle/tube into the BOTTOM drain hole. Then slowly squeeze the bottle to force the oil into the lower unit.



**Only use Synthetic API GL5, SAE#80 to #90 Gear Oil, do not mix different oil brands or weights.**

- Continue adding oil until the lubricant is flowing freely from the top hole and is free from air bubbles. About 17 Oz or 500ml.



- Keep the bottle/tube in the bottom plug (or plug the hole with your finger) and re-install the TOP plug. This will create a slight vacuum that will minimize the oil loss while you reinstall the bottom plug.
- Now, QUICKLY remove the bottle (or your finger) from the bottom hole and install the drain plug. It is important to do this as quickly as possible to minimize the amount of oil loss. Even though there is a slight vacuum, there will still be some loss of oil. Do not be concerned about losing some oil, however, if you lose an excessive amount of oil you will need to go back and add additional oil. Hand tighten both the lower and upper drain plugs and wipe off any oil on your lower unit.



**Running your outboard without completely filling the lower unit with oil to the proper level will cause severe damage to your outboard. See the comments at the end of this guide on how to check for the proper oil level in your lower unit.**

#### Inspect Oil

- Oil emulsification. The presence of water in the gear oil will cause the oil to look “milky”, this is an indicator that a shaft seal is going bad or the O-rings for either the fill or drain plug.
- Metal shavings. The presence of small “sand like” shavings are common and consistent with normal wear. Should larger pieces or “chunks” with a grey oil color be observed, indicates a more significant problem. Consider a lower unit swap or depot level service.



#### Check Oil Level

- Remove the top oil plug, insert a small piece of wire straight into the top hole approximately 1 inch and withdraw the wire. If oil is on the wire the oil level is correct, if not the unit must be refilled to the correct level.
- To add ("top-off") oil install the top plug again, remove the bottom plug and put your oil bottle into the hole. Remove the top plug to release the vacuum and add the necessary amount of oil. Reinstall the top plug, then quickly reinstall the bottom plug. Check the oil level once again as described above.

### GEARCASE PRESSURE AND VACUUM TESTS

Lower Unit or Gearcase testing is sometimes required based on indicators noted during routine maintenance of the motor or based on unforeseen maintenance actions due to equipment failure. These tests are a definitive way to determine if your seals are faulty.

#### Test Procedure

- Drain the oil from the gearcase as specified within this section.
- Ensure that the Oil Fill Plug is reinstalled.
- Install the gearcase pressure tester into the Oil Level Plug fitting.
- Pump the pressure tester until the gauge indicates 3-6 PSI. Gearcase should maintain pressure for 2 minutes.
- If pressure loss occurs, determine source by submerging gearcase in water.
- Once source is identified, make necessary repairs to correct the problem and retest.
- Remove the pressure tester and install the gearcase vacuum tester.
- pump vacuum tester until gauge indicates 3 - 5 in of mercury. Gearcase should maintain vacuum for 2 minutes.
- If loss of vacuum occurs, apply oil around suspected seal. If leak stops or oil is drawn in, the seal is defective and must be replaced.
- Make necessary repairs to correct the problem and retest.

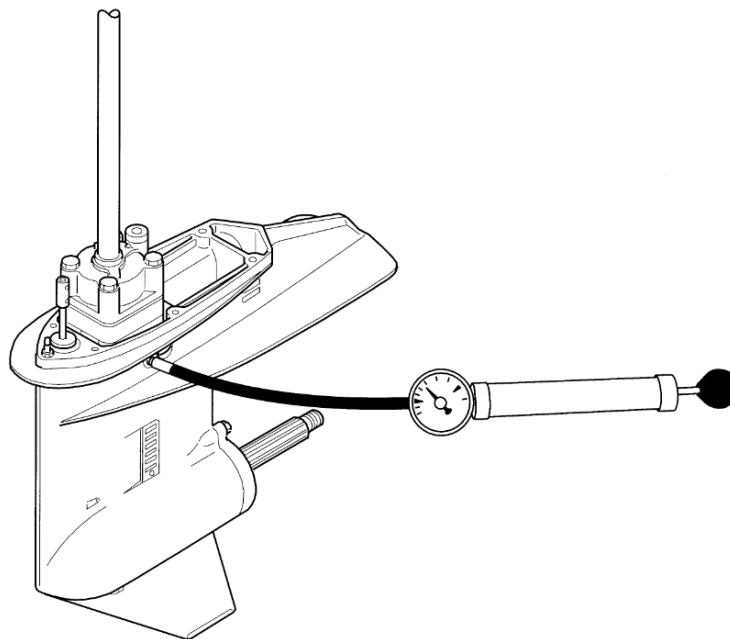

**TROUBLESHOOTING**

If you encounter a problem with the engine, check the list below. Locate the problem you are experiencing, then follow the suggested remedies. Do not hesitate to contact Raider Technical Support, as professional advice and assistance is the best way to keep the engine in optimum condition.

| Difficult to start engine | Engine starts, but stops soon | Poor Idling | Unstable engine running speed or engine speed | Abnormally high engine speed | Abnormally low engine speeds | Cannot obtain high engine speeds | Over-heating of engine |  |
|---------------------------|-------------------------------|-------------|---|------------------------------|------------------------------|----------------------------------|------------------------|--|
| •                         | •                             |             | •   |                              |                              |                                  |                        | Empty fuel tank                              |
| •                         | •                             | •           | •   |                              | •                            | •                                | •                      | Incorrect connection of fuel system          |
| •                         | •                             | •           | •   |                              | •                            | •                                | •                      | Air enters fuel line                         |
| •                         | •                             | •           | •   |                              | •                            | •                                | •                      | Deformed or damaged fuel pipe                |
| •                         | •                             | •           | •   |                              | •                            | •                                | •                      | Closed air vent on fuel tank cap             |
| •                         | •                             | •           | •   |                              | •                            | •                                | •                      | Clogged fuel filter, fuel pump or carburetor |
|                           |                               | •           | •   |                              | •                            | •                                | •                      | Use of improper engine Oil                   |
| •                         | •                             | •           | •   |                              |                              | •                                | •                      | Use of improper Gasoline                     |
| •                         | •                             |             |   |                              |                              |                                  |                        | Excessive supply of gasoline                 |
| •                         | •                             | •           | •   |                              | •                            | •                                | •                      | Poor carburetor Adjustment                   |
| •                         | •                             | •           | •   |                              |                              | •                                | •                      | Recirculation pipe Broken                    |
| •                         | •                             | •           | •   |                              | •                            | •                                | •                      | Use of non-specified spark plugs             |
| •                         | •                             | •           | •   |                              | •                            | •                                |                        | Dirt or carbon deposits on spark plugs       |
| •                         | •                             | •           | •   |                              | •                            | •                                |                        | No sparks or weak Sparks                     |
|                           |                               |             | •   |                              | •                            | •                                | •                      | Insufficient cooling water flow              |

| Difficult to start engine | Engine starts, but stops soon | Poor Idling | Unstable engine running speed or engine speed | Abnormally high engine speed | Abnormally low engine speeds | Cannot obtain high engine speeds | Over-heating of engine |   |
|---------------------------|-------------------------------|-------------|---|------------------------------|------------------------------|----------------------------------|------------------------|---|
|                           |                               | ●           | ●   |                              |                              | ●                                | ●                      | Faulty thermostat   |
|                           |                               |             |   | ●                            |                              | ●                                | ●                      | Propeller cavitation                                      |
|                           |                               |             |   | ●                            | ●                            | ●                                | ●                      | Incorrect propeller selection                             |
|                           |                               | ●           |   | ●                            | ●                            | ●                                | ●                      | Damaged or bent propeller                                 |
|                           |                               |             |   | ●                            | ●                            | ●                                | ●                      | Unbalanced load in boat                                   |
|                           |                               |             |   | ●                            |                              | ●                                | ●                      | Transom too high  |
|                           |                               |             |   |                              | ●                            | ●                                | ●                      | Transom too low   |
| ●                         | ●                             | ●           |   |                              | ●                            | ●                                | ●                      | Incorrect adjustment of throttle link                     |
| ●                         | ●                             | ●           |   |                              | ●                            | ●                                | ●                      | Incorrect adjustment of ignition timing                   |
| ●                         |                               |             |   |                              |                              |                                  |                        | Insufficient battery capacity, loose terminals, corrosion |
| ●                         |                               |             |   |                              |                              |                                  |                        | Safety switch lock plate not fitted                       |



# **APPENDICES**

## PRE OPERATIONS CHECKLIST

|                             |  |                     |  |                           |  |
|-----------------------------|--|---------------------|--|---------------------------|--|
| <b>Motor Serial Number:</b> |  | <b>Motor Hours:</b> |  | <b>Date of Operation:</b> |  |
|-----------------------------|--|---------------------|--|---------------------------|--|

Before placing the Raider Outboard 40 into service and or starting the engine, complete the checks listed in the Preoperational Checklist. The Preoperational Checklist is designed to ensure that the motor and all systems are in proper working order to support motor operation, and to ensure safe and efficient boat operation.

**NOTE:** The Preoperational Checklist may be modified to meet operational commitments. Not all steps may be required every time prior to start.

**NOTE:** This list of preoperational checks is not inclusive.

| <i>General Checks</i> |   |   | <b>Completed (initial)</b> |
|-----------------------|---|---|----------------------------|
| <i>a.</i>             | Exterior  | <ul style="list-style-type: none"> <li>Inspect Cowling, Engine Pan, Midsection, and Lower Unit for cracks, defects, or damage.</li> </ul>   | <i>a.</i>                  |
| <i>b.</i>             | Zinc Anodes   | <ul style="list-style-type: none"> <li>Stern Brackett Anode. Replace if damaged or reduced in size by more than 40%.</li> <li>Trim Tab Anode. Replace if damaged or reduced in size by more than 40%.</li> </ul>  | <i>b.</i>                  |
| <i>c.</i>             | Control Panel   | <ul style="list-style-type: none"> <li>Inspect the Start and Stop controls.</li> <li>Verify the Lock Plate and Lanyard are installed.</li> <li>Inspect for damage due to corrosion, lack of maintenance, or abuse. Loose ball joints, locknuts, bent link rods, loose rod snaps.</li> </ul> | <i>c.</i>                  |
| <i>d.</i>             | Cable Lanyard   | <ul style="list-style-type: none"> <li>Verify the Cable Lanyard is securely attached to the motor and maybe securely attached to craft Transom.</li> </ul>  | <i>d.</i>                  |
| <i>e.</i>             | Shift Lever Mechanism and Shift Lever Stopper                             | <ul style="list-style-type: none"> <li>Inspect for damage due to corrosion, lack of maintenance, or abuse. Loose ball joints, locknuts, bent link rods, loose rod snaps.</li> </ul>   | <i>e.</i>                  |
| <i>f.</i>             | Throttle Linkage  | <ul style="list-style-type: none"> <li>Inspect for damage due to corrosion, lack of maintenance, or abuse. Loose ball joints, locknuts, bent link rods, loose rod snaps.</li> <li>Lubricate with low temperature lithium grease.</li> </ul>   | <i>f.</i>                  |
| <i>g.</i>             | Throttle Advancer Arm and Rod, Throttle Mechanism, Handel, and Grip.      | <ul style="list-style-type: none"> <li>Inspect for damage due to corrosion, lack of maintenance, or abuse. Loose ball joints, locknuts, bent link rods, loose rod snaps.</li> <li>Lubricate with Friction Surface Marine Grease.</li> </ul>   | <i>g.</i>                  |
| <i>h.</i>             | Tilt Stopper, Bracket Bolt, Bracket Shaft, Clamp Screw, and Reverse Lock. | <ul style="list-style-type: none"> <li>Inspect for damage due to corrosion, lack of maintenance, or abuse.</li> <li>Lubricate with Friction Surface Marine Grease.</li> </ul>   | <i>h.</i>                  |
| <i>i.</i>             | Hook Lever Mechanism (cowling)  | <ul style="list-style-type: none"> <li>Inspect for damage due to corrosion, lack of maintenance, or abuse.</li> <li>Lubricate with Friction Surface Marine Grease.</li> </ul>   | <i>i.</i>                  |
| <i>j.</i>             | Recoil Starter  | <ul style="list-style-type: none"> <li>Inspect for damage due to corrosion, lack of maintenance, or abuse.</li> <li>Lubricate with Friction Surface Marine Grease.</li> </ul>   | <i>j.</i>                  |

|                    |                               |   |                                |
|--------------------|-------------------------------|---|--------------------------------|
| k.                 | Starter Lock                  | <ul style="list-style-type: none"> <li>Inspect for damage due to corrosion, lack of maintenance, or abuse.</li> <li>Lubricate with Friction Surface Marine Grease.</li> </ul>   | k.                             |
| l.                 | Battery                       | <ul style="list-style-type: none"> <li>Inspect battery case for damage.</li> <li>Inspect cables for cracks, chaffing and insulation damage.</li> <li>Check battery mounting.</li> <li>Inspect battery connector for corrosion.</li> <li>Lubricate battery connector with dielectric grease.</li> </ul>  | l.                             |
| m.                 | Electrical Wiring             | <ul style="list-style-type: none"> <li>Inspect wires for cracks, chaffing and insulation damage.</li> <li>Check for loose connections.</li> </ul>   | m.                             |
| n.                 | Ignition Coil Plug Wire Boots | <ul style="list-style-type: none"> <li>Prior to submersion, remove plug boots and fill with dielectric grease.</li> </ul>   | n.                             |
| o.                 | Gearcase                      | <ul style="list-style-type: none"> <li>Inspect water intake screens</li> <li>Inspect Skeg for damage</li> </ul>   | o.                             |
| p.                 | Propeller                     | <ul style="list-style-type: none"> <li>Inspect and verify propeller is true and free of nicks, chips, and other damage that could affect performance.</li> </ul>  | p.                             |
| q.                 | Propeller Shaft               | <ul style="list-style-type: none"> <li>Inspect for damage due to corrosion, lack of maintenance, or abuse. Inspect the shaft threads and splines for wear and damage.</li> <li>Lubricate with Friction Surface Marine Grease.</li> </ul>  | q.                             |
| <b>Fuel System</b> |                               |   | <b>Completed<br/>(initial)</b> |
| a.                 | Gasoline Fuel Mix Ratio       | <ul style="list-style-type: none"> <li>Requires a 40:1 oil to fuel mixture. 16oz per six (6) gallons or about 2.5oz per every one (1) gallon.</li> <li>Use only NMMA TC-W3 2-Cycle motor Oil.</li> <li>Record date of mix, dispose of fuel mixtures older than 90 days.</li> </ul>  | a.                             |
| b.                 | Heavy Fuel Mix Ratio          | <ul style="list-style-type: none"> <li>Requires a 12:1 Raider Elixir mixture. One (1) can Raider Additive per six (6) gallon of fuel. 64oz per six (6) gallons or about 10.5oz per every one (1) gallon of fuel in addition to the 40:1 oil to fuel mixture.</li> <li>Use only NMMA TC-W3 2-Cycle motor Oil.</li> <li>Record date of mix, dispose of fuel mixtures older than 90 days</li> </ul>                                | b.                             |
| c.                 | Fuel Bladder/Tank             | <ul style="list-style-type: none"> <li>Inspect for leaks: Ensure that the bladder is not leaking from any seam, fill cap, vent, or rip in membrane.</li> <li>Inspect securing straps: Ensure the bladder can be adequately secured to the deck.</li> <li>Inspect fuel line connector: Check for damage and ensure that the fuel line fitting properly mates.</li> <li>Inspect vent: Ensure the vent opens and shuts.</li> </ul> | c.                             |
| d.                 | Fuel Line Assembly            | <ul style="list-style-type: none"> <li>Inspect end connectors: Check ensuring proper fit and seal to bladder and Raider.</li> <li>Inspect fuel line: Check for dry rot and leaks.</li> <li>Inspect bulb: Check for proper installation, dry rot, and function.</li> <li>Stow extra Fuel Line Assembly in sponson bag or Emergency Kit.</li> </ul>   | d.                             |
| e.                 | Heavy Fuel Block Valve        | <ul style="list-style-type: none"> <li>Ensure that the Heavy Fuel Block Selector Valve is lock wired in the shut position when using gasoline.</li> </ul>   | e.                             |
| f.                 | Fuel Filter                   | <ul style="list-style-type: none"> <li>Inspect component for leaks, damage, or excessive wear.</li> <li>Inspect Clamps: Ensuring proper fit, note leaks, damage, or excessive wear.</li> <li>Inspect Lines: Check for dry rot and chaffing.</li> </ul>  | f.                             |

| g.                 | Fuel Pump                        | <ul style="list-style-type: none"> <li>Inspect component for leaks, damage, or excessive wear.</li> <li>Inspect Clamps: Ensuring proper fit, note leaks, damage, or excessive wear.</li> <li>Inspect Lines: Check for dry rot and chaffing.</li> </ul> | g.                     |
|--------------------|----------------------------------|--|------------------------|
| h.                 | Carburetor                       | <ul style="list-style-type: none"> <li>Inspect component for leaks, damage, or excessive wear.</li> <li>Inspect Clamps: Ensuring proper fit, note leaks, damage, or excessive wear.</li> <li>Inspect Lines: Check for dry rot and chaffing.</li> </ul> | h.                     |
| i.                 | Primer                           | <ul style="list-style-type: none"> <li>Inspect for damage due to corrosion, lack of maintenance, or abuse. Loose ball joints, locknuts, bent link rods, loose rod snaps.</li> <li>Lubricate with Friction Surface Marine Grease.</li> </ul>            | i.                     |
| Operational Checks |                                  |  | Completed<br>(initial) |
| a.                 | Pull Start                       | <ul style="list-style-type: none"> <li>Start the motor using the recoil starter.</li> </ul>  | a.                     |
| b.                 | Electric Start                   | <ul style="list-style-type: none"> <li>Start the motor using the electric start push button.</li> </ul>  | b.                     |
| c.                 | Neutral Safety                   | <ul style="list-style-type: none"> <li>Verify that the motor will not start in gear both forward and reverse.</li> </ul>   | c.                     |
| d.                 | Water discharge from check ports | <ul style="list-style-type: none"> <li>When the motor is running verify that water is being discharged from all check ports.</li> </ul>  | d.                     |
| e.                 | Tiller Steering                  | <ul style="list-style-type: none"> <li>When moving the Tiller Arm, verify that the motor moves freely to port and starboard.</li> </ul>  | e.                     |
| f.                 | Neutral                          | <ul style="list-style-type: none"> <li>Verify the propeller does not engage when the gear selector is in the neutral position.</li> </ul>  | f.                     |
| g.                 | Forward                          | <ul style="list-style-type: none"> <li>With the motor at idle, verify the Gear Selector moves freely into the forward position and the propeller engages.</li> </ul>   | g.                     |
| h.                 | Reverse                          | <ul style="list-style-type: none"> <li>With the motor at idle, verify the Gear Selector moves freely into the reverse position and the propeller engages.</li> </ul>   | h.                     |
| i.                 | Throttle Control                 | <ul style="list-style-type: none"> <li>With the engine in neutral, slowly increase the throttle RPM's to approximately.</li> </ul>   | i.                     |
| j.                 | Emergency Stop Switch            | <ul style="list-style-type: none"> <li>While the motor is running, remove the lock plate, the motor should stop.</li> </ul>  | j.                     |
| k.                 | Engine Stop Switch               | <ul style="list-style-type: none"> <li>While the motor is running, press the Engine Stop Switch, the motor should stop.</li> </ul>   | k.                     |
| l.                 | Shallow Water Running            | <ul style="list-style-type: none"> <li>Move the motor Reverse Lock Lever to the release position, lift the lower unit past a 45° angle until the tilt stopper assembly locks.</li> </ul>   | l.                     |
| m.                 | Full Tilt Position               | <ul style="list-style-type: none"> <li>Move the motor Reverse Lock Lever to the release position, lift the Lower Unit past a 90° angle until the tilt stopper assembly locks.</li> </ul>   |                        |



**POST OPERATIONS CHECKLIST**

|                             |  |                     |  |                           |  |
|-----------------------------|--|---------------------|--|---------------------------|--|
| <b>Motor Serial Number:</b> |  | <b>Motor Hours:</b> |  | <b>Date of Operation:</b> |  |
|-----------------------------|--|---------------------|--|---------------------------|--|

Complete the checks listed in the post-operational checklist. The post-operational checklist is designed to ensure all systems are secured properly and the boat is prepared for future missions.

| Post Operations Checks                              |  | Completed (initial) |
|---|--|---------------------|
| a. Fresh water wash-down (Salt-Away is recommended) | <ul style="list-style-type: none"> <li>Wash the exterior of the motor with fresh water.</li> <li>Remove the motor cowling and fresh water wash the powerhead.</li> <li>After submersion period ensure fresh water is forced under the flywheel and Recoil Starter.</li> <li>After submersion fully extend the Recoil Starter Line/Rope and wash with fresh water.</li> </ul>   | a.                  |
| b. Fresh water motor flush                          | <ul style="list-style-type: none"> <li>Attach "ears or flush connector" to lower unit. Operate the engine for approximately five (5) minutes at full operating temperature.</li> <li>After submersion period the motor must be run at operating temperature for no less than 30 minutes to ensure all water is removed from the head.</li> <li>Disconnect the fuel supply and let the motor run itself dry.</li> </ul> | b.                  |
| c. Wipe down  | <ul style="list-style-type: none"> <li>Use LP air or dry cloth to remove excess water from exterior and interior surfaces of the motor.</li> <li>After submersion use LP air to remove water and moisture under the Flywheel and Recoil Starter.</li> </ul>  | c.                  |
| d. Corrosion Prevention                             | <ul style="list-style-type: none"> <li>Spray the Powerhead with a liberal coat of Anti-Corrosion Spray penetrant/lubricant or equivalent.</li> <li>Spray 6 &amp; 1 Penetrating Lubricant or equivalent under the flywheel.</li> </ul>  | d.                  |
| e. Battery Maintenance                              | <ul style="list-style-type: none"> <li>Unplug or remove battery – place on battery tender to maintain charge.</li> </ul>   | e.                  |
| f. Air Dry  | <ul style="list-style-type: none"> <li>Leave the upper cover off, when possible to allow the powerhead and other components to air dry.</li> </ul>   | f.                  |



---

**This page intentionally left blank**

---



